

narbutas



3 **Sit-stand desks**
Bureaux assis / debout | Steh-Sitz-Tische

15 **Desks**
Bureaux | Büroschreibtische

31 **Acoustic screens**
Ecrans acoustiques | Akustisch-wirksame Sichtblenden

37 **Acoustic furniture**
Meubles acoustiques | Akustisch-wirksame Möbel

Acoustic panels
Panneaux acoustiques | Akustisch-wirksame Paneele

45 **Cabinets**
Armoires de bureau | Schränke

Towers
Caissons hauts | Apothekenschränke

Pedestals
Caissons | Rollcontainer

63 **Meeting tables**
Tables de réunion | Besprechungstische

High tables
Tables hautes | Hochtische

Conference tables
Tables de conference | Konferenztische

Media units
Panneau Media | Media-wand

Coffee tables
Tables basses | Niedriger Beistelltisch

77 **Executive furniture**
Mobilier de direction | Chefzimmer

87 **Reception furniture**
Mobilier d'accueil | Empfangsmöbel

Sit-stand desks

Bureaux assis / debout | Steh-Sitz-Tische

MOTION

JAZZ

EASY

ONE



MOTION

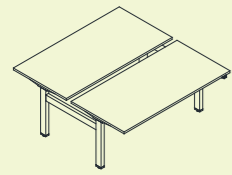

1400x1674x700-1200
1600x1674x700-1200

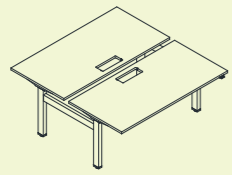

1400x1674x700-1200
1600x1674x700-1200

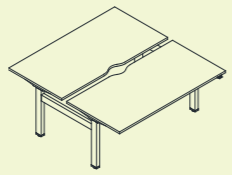

1400x1674x700-1200
1600x1674x700-1200

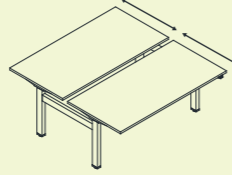

1400x1674x700-1200
1600x1674x700-1200

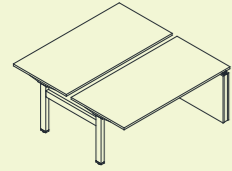

1400x1674x700-1200
1600x1674x700-1200

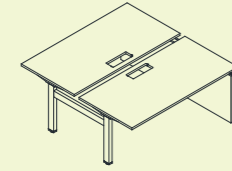

1400x1674x700-1200
1600x1674x700-1200

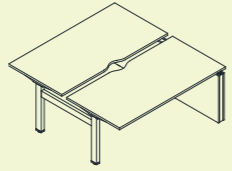

1400x1674x700-1200
1600x1674x700-1200

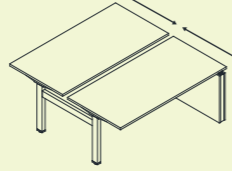

1400x1674x700-1200
1600x1674x700-1200

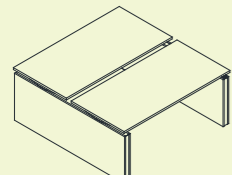

1400x1674x700-1200
1600x1674x700-1200

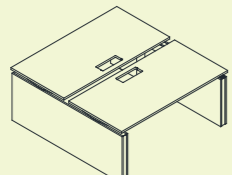

1400x1674x700-1200
1600x1674x700-1200

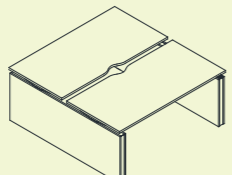

1400x1674x700-1200
1600x1674x700-1200

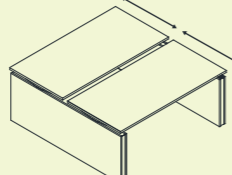

1400x1674x700-1200
1600x1674x700-1200

JAZZ

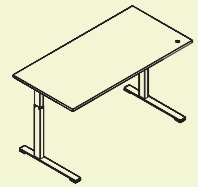

1400x800x710-1210
1600x800x710-1210

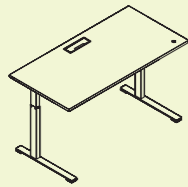

1400x800x710-1210
1600x800x710-1210

EASY

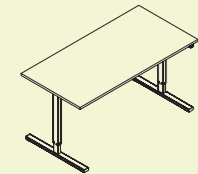

1400x800x705-1205
1600x800x705-1205

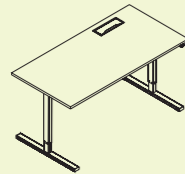

1400x800x705-1205
1600x800x705-1205

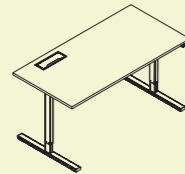

1400x800x705-1205
1600x800x705-1205

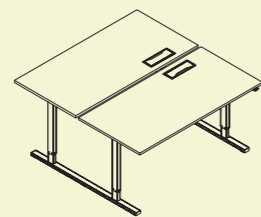

1400x1640x705-1205
1600x1640x705-1205

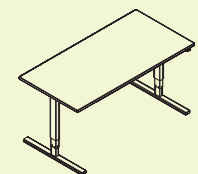

1400x800x610-1260
1600x800x610-1260

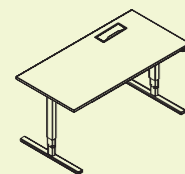

1400x800x610-1260
1600x800x610-1260

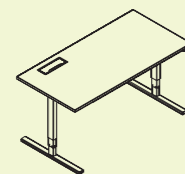

1400x800x610-1260
1600x800x610-1260

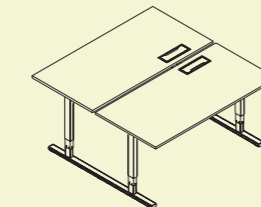

1400x1640x610-1260
1600x1640x610-1260

ONE

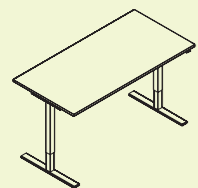

1400x700x705-1185
1400x700x705-1185
1600x800x705-1185
1600x800x705-1185

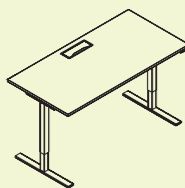

1400x700x705-1185
1400x700x705-1185
1600x800x705-1185
1600x800x705-1185



700 – 1200 mm

MOTION



MOTION

Electric height adjustable bench desks for more dynamic and healthy work style.

Système de bureaux agencés avec hauteur réglable électriquement pour un travail dynamique.

Ist ein Tischsystem der elektrisch verstellbaren Höhe, das für dynamisches Arbeiten bestimmt ist.

JAZZ

design by Christina Strand and Niels Hvass





EASY

These are one of the most functional sit-stand desks to maintain your concentration and productivity. EASY desks have several construction options such as different column level legs, types of feet and buttons.

Height adjustment range: 2 column – 705 - 1205 mm and 3 column – 610- 1260 mm.

Ce sont des bureaux extrêmement fonctionnels commandés électriquement qui améliorent le travail : augmentation de la concentration et de la productivité. Les bureaux EASY offrent différents styles de pieds de boutons.

Hauteur des bureaux : avec 2 colonnes : 705-1205 mm ; avec 3 colonnes : 610- 1260 mm.

Die funktionalen Tische EASY sind elektrisch verstellbar und sorgen durch die optimierten Arbeitsbedingungen für mehr Konzentration und Produktivität. EASY-Tische sind mit unterschiedlichen Säulen und Tasten erhältlich.

Wählen Sie zwischen Tischen mit Zweifachsäulen (705-1205 mm) und Dreifachsäulen (610- 1260 mm).





ONE

Electric adjustable desks increase your daily work efficiency. ONE desks have several advantages: the motor operates very silently and consumes little power. Also, you can choose from two types of feet and add extra panels to absorb sound even better.

Ces bureaux commandés électriquement optimisent le travail au quotidien. Ils offrent des solutions optimales grâce à un mécanisme silencieux utilisant peu d'énergie. Il est possible de choisir différents styles de pieds et de fixer des panneaux-écrans acoustiques.

Elektrisch verstellbare Tische, die die positiven Auswirkungen auf die tägliche Arbeit maximieren. Auch die Tische selbst sind optimal konzipiert, denn der Mechanismus arbeitet geräuschlos und verbraucht wenig Strom. Sie können zwischen verschiedenen Tischbeinen wählen sowie schallabsorbierende Trennwände befestigen.

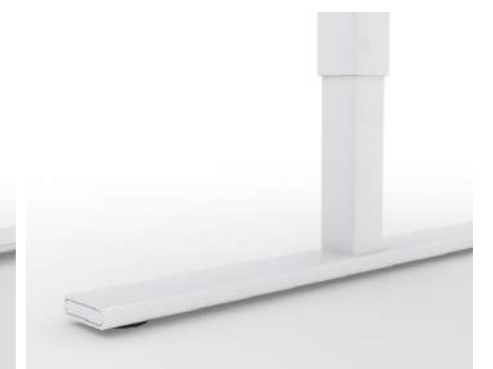



Desks

Bureaux | Büroschreibtische

JAZZ

AIR

NOVA U

NOVA U Slide

NOVA H

NOVA A

NOVA O

T-EASY

ONE H

OPTIMA C

OPTIMA G

OPTIMA Plus



JAZZ

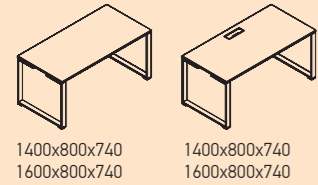

1400x800x740
1600x800x740

T-EASY

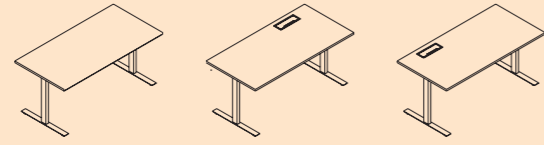

1400x800x740
1600x800x740

ONE H

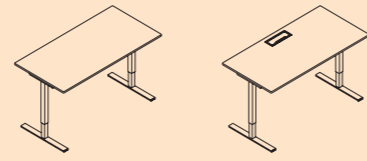

1400x700x620-850
1600x700x620-850
1400x800x620-850
1600x800x620-850

NOVA O

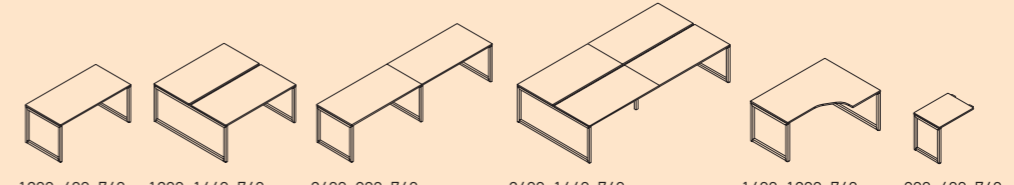

1200x600x740
1400x600x740
1200x700x740
1200x800x740
1400x700x740
1400x800x740
1600x700x740
1600x800x740
1800x700x740
1800x800x740

1200x1440x740
1400x1440x740
1400x1640x740
1600x1440x740
1600x1640x740
1800x1440x740
1800x1640x740

2400x800x740
2800x800x740
3200x800x740
3600x800x740

2400x1440x740
2400x1640x740
2800x1440x740
2800x1640x740
3200x1440x740
3200x1640x740
3600x1440x740
3600x1640x740

1400x1200x740
1600x1200x740
1800x1200x740

800x600x740

AIR

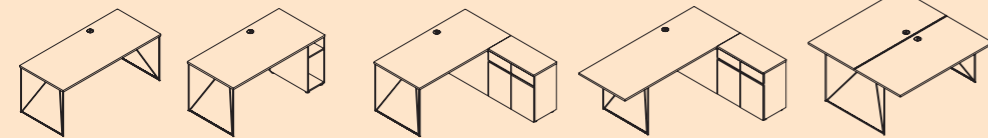

1600x800x740
1800x800x740

1600x800x740
1800x800x740

1600x1600x740
1800x1600x740

2000x1600x740

1600x1600x740

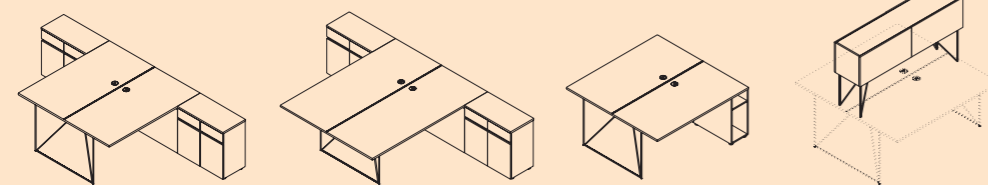

1600x3200x740

2000x3200x740

1600x1600x740

1600x400x855

NOVA U

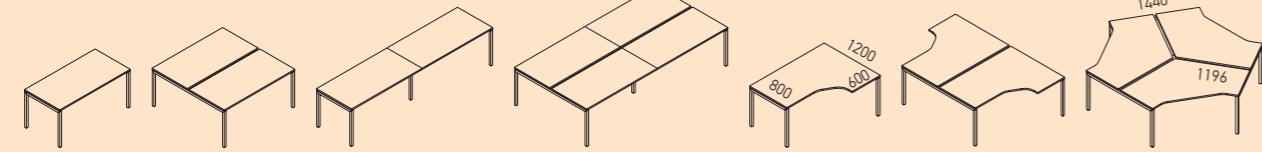

1200x600x740
1200x700x740
1200x800x740
1400x600x740
1400x700x740
1400x800x740
1600x700x740
1600x800x740
1800x700x740
1800x800x740

1200x1440x740
1200x1640x740
1400x1440x740
1400x1640x740
1600x1440x740
1600x1640x740
1800x1440x740
1800x1640x740

2400x800x740
2800x800x740
3200x800x740
3600x800x740

2400x1440x740
2400x1640x740
2800x1440x740
2800x1640x740
3200x1440x740
3200x1640x740
3600x1440x740
3600x1640x740

1400x1200x740
1600x1200x740
1800x1200x740

1400x2440x740
1600x2440x740
1800x2440x740

Ø2810x740

800x600x740
600x800x740

1440x600x740
1640x600x740

NOVA U Slide

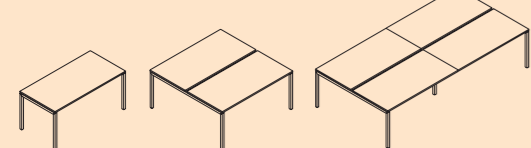

1400x700x743
1400x800x743
1600x700x743
1600x800x743

1400x1440x743
1400x1640x743
1600x1440x743
1600x1640x743

2800x1440x743
2800x1640x743
3200x1440x743
3200x1640x743

NOVA H

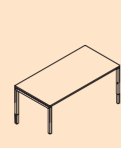

1200x800x620-850
1400x800x620-850
1600x1200x620-850
1800x1200x620-850

NOVA A

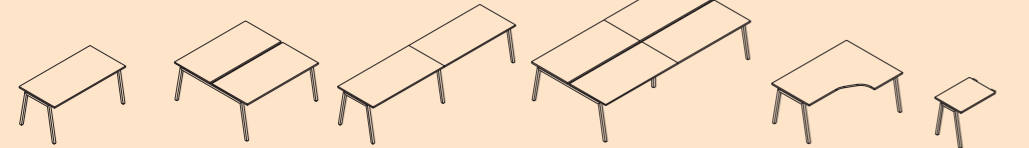

1200x600x740
1400x600x740
1200x700x740
1200x800x740
1400x700x740
1400x800x740
1600x700x740
1600x800x740
1800x700x740
1800x800x740

1200x1440x740
1200x1640x740
1400x1440x740
1400x1640x740
1600x1440x740
1600x1640x740
1800x1440x740
1800x1640x740

2400x800x740
2800x800x740
3200x800x740
3600x800x740

2400x1440x740
2400x1640x740
2800x1440x740
2800x1640x740
3200x1440x740
3200x1640x740
3600x1440x740
3600x1640x740

1400x1200x740
1600x1200x740
1800x1200x740

800x600x740

OPTIMA C

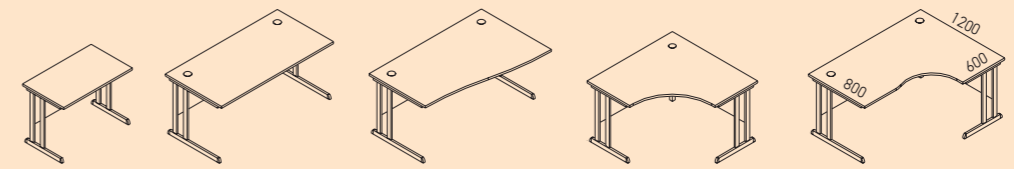

800x600x720
1000x600x720
1200x600x720

800x800x720
1000x800x720
1200x800x720
1400x800x720
1600x800x720
1800x800x720

1200x1000x720
1400x1000x720
1600x1000x720

1200x1200x720

1400x1200x720
1600x1200x720
1800x1200x720

OPTIMA G

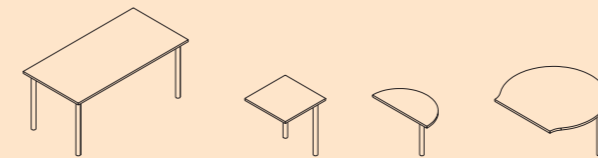

800x800x720
1200x700x720
1200x800x720
1400x700x720
1400x800x720
1600x700x720
1600x800x720
1800x800x720

600x600x720
800x600x720
1200x600x720

Ø400x720

Ø1000x720

OPTIMA Plus

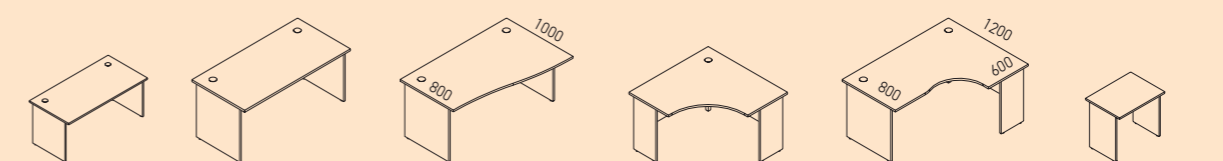

800x600x720
1000x600x720
1200x600x720

800x800x720
1000x800x720
1200x800x720
1400x800x720
1600x800x720
1800x800x720

1200x1000x720
1400x1000x720
1600x1000x720

1200x1200x720

1400x1200x720
1600x1200x720
1800x1200x720

800x600x720
1000x600x720
1200x600x720



JAZZ

design by Christina Strand and Niels Hvass

It is characterized by progressive structural design that creates an exclusively unique style.

Caractérisé par la conception d'une structure simple et innovante, ce qui crée un style unique.

Die Stärke von JAZZ ist das einfache, dabei fortschrittliche Design, das einen einzigartigen Stil generiert.





AIR

design by Gediminas Juška

It is a perfect combination of lightness and functionality. To keep your workspace clean and uncluttered, we have also created soft closing AIR cabinets.

AIR – un mélange de légèreté et de fonctionnalité. Au-dessus du bureau AIR est fixé un meuble de rangement facilement accessible à la main et qui possède un mécanisme de fermeture silencieux. On peut y placer des objets en gardant ainsi un espace de travail propre et non encombré.

Die Serie AIR steht für Leichtigkeit und Funktionalität. Über dem AIR Arbeitstisch ist in bequemer Reichweite ein Schrank mit geräuschlosem Schließmechanismus angebracht. Hier können Sie verschiedene Dinge unterbringen, damit Ihr Arbeitsplatz immer aufgeräumt erscheint.





NOVA U

It is universal desking system. A perfect combination of classic and modern: modest minimalism, functionality and laconic lines.

NOVA U – un système universel de bureaux. Mélange de classique et de moderne : minimalisme modéré, fonctionnalité, lignes épurées.

Ein besonders vielseitiges Tischsystem, in dem Klassik und Moderne harmonieren: moderater Minimalismus, Funktionalität und schnörkellose Linien.



NOVA U Slide

An exclusively functional office desking system with sliding desktop for convenient wiring of all the IT cables you might need at your workspace.

NOVA U Slide – sont des bureaux purement fonctionnels avec des plans de travail extensibles, permettant un accès aisé au bloc électrique et au câblage.

Funktionale Tische mit ausziehbarer Arbeitsplatte für schnellen Zugriff auf die verdeckte Stromversorgung und Kabelführung.

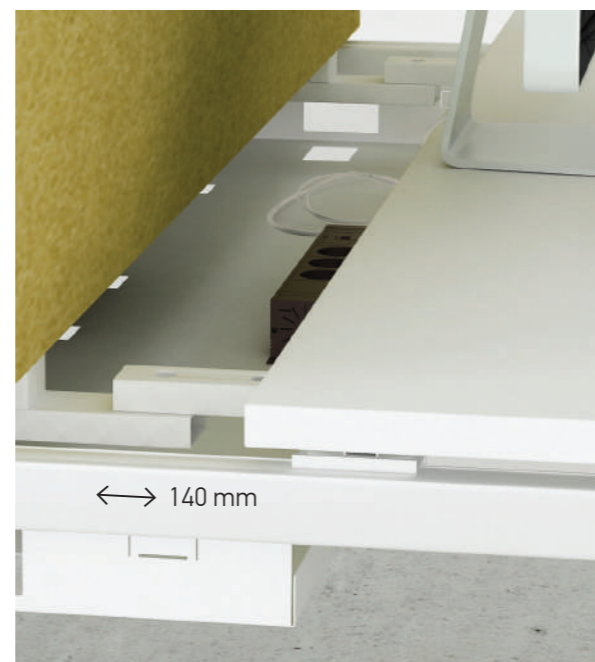

NOVA H

Simple manual height adjustment system allows you to change the desktop height.

L'ajustement des pieds des tables NOVA H permet d'adapter la hauteur du plan de travail de 620 mm à 850 mm.

Dank der verstellbaren Tischbeine können Sie für Ihre Arbeitsplatte Höhen zwischen 620 mm und 850 mm auswählen.



NOVA A

Light, graceful and modern desking system is designed to highlight the exclusivity of your team.

Un design épuré et moderne offrant un environnement jeune et léger tout en mettant l'accent sur le caractère unique de votre équipe.

Das schlanke und moderne Design verleiht der Büroumgebung eine jugendliche Note und betont die Einzigartigkeit Ihres Teams.



NOVA O

Desks with square-shaped legs create expressive geometric character in the office. NOVA towers go well with all of the NOVA desks and are perfect for storing your files or personal belongings.

Les pieds de la table carrée ou rectangulaire créent des formes géométriques expressives de l'intérieur. Les rangements NOVA peuvent être couplés avec toutes les tables du système, et sont adaptés pour les classeurs et pour tous les objets de travail ou personnels.

Regelmäßig geformte quadratische oder rechteckige Tischbeine sorgen für ausdrucksvolle geometrische Formen im Interieur.

Die NOVA Staukästen lassen sich mit allen Tischen des Systems kombinieren und eignen sich zum Ablegen von Ordnern oder persönlichen Gegenständen.





T-EASY

ONE H

Simple manual height adjustment system allows you to change the desktop height from 620 mm to 850 mm.

L'ajustement des pieds des tables ONE H permet d'adapter la hauteur du plan de travail de 620 mm à 850 mm.

Dank der verstellbaren Tischbeine können Sie für Ihre Arbeitsplatte Höhen zwischen 620 mm und 850 mm auswählen.



OPTIMA C



Acoustic screens

Ecrans acoustiques | Akustisch-wirksame Sichtblenden

TOP 530

DESK 760

MODUS

FREE STANDING



OPTIMA G



TOP 530

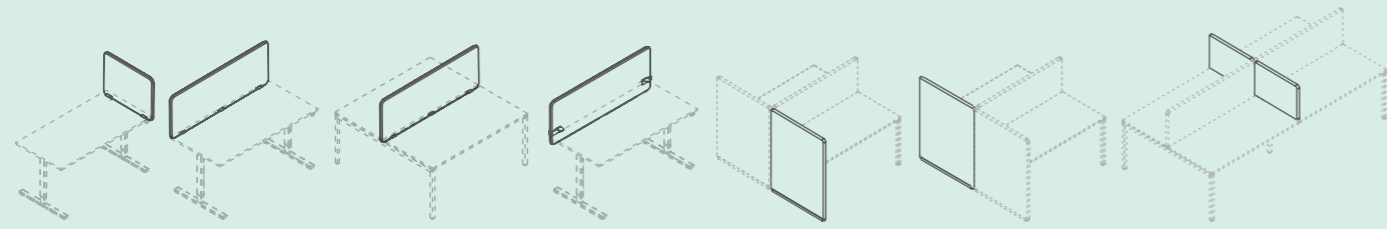

700x36x595	1200x36x595	1200x36x555	1200x36x595	1270(530)x1000x36	1270(530)x1000x36	(710x2)x36x530
800x36x595	1400x36x595	1400x36x555	1400x36x595			(810x2)x36x530
	1600x36x595	1600x36x555	1600x36x595			
	1800x36x595	1800x36x555	1800x36x595			

DESK 760

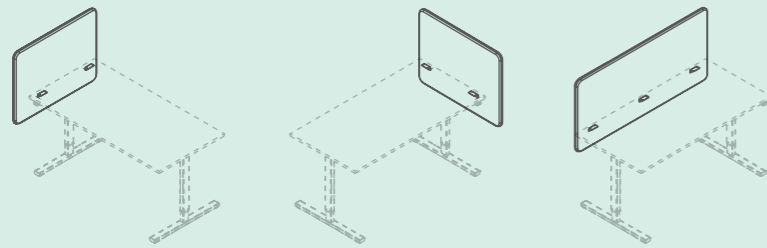

1000x36x760	1000x36x760	1400x36x760
		1600x36x760

MODUS

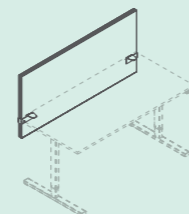

1400x42x740
1600x42x740

FREE STANDING

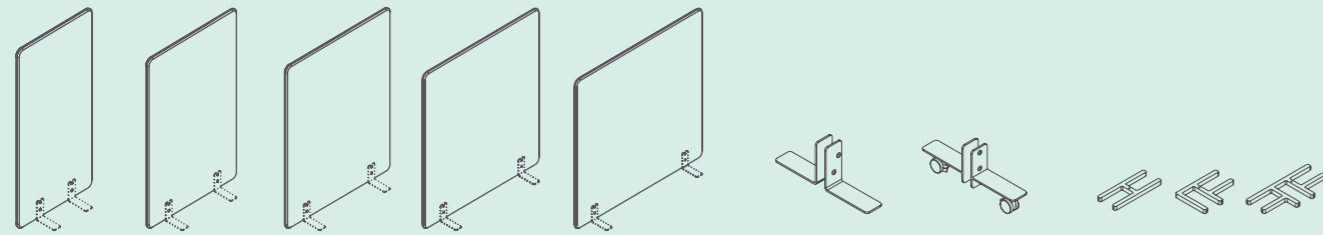

800x36x1190	1000x36x1190	1200x36x1190	1400x36x1190	1600x36x1190
800x36x1390	1000x36x1390	1200x36x1390	1400x36x1390	1600x36x1390
800x36x1590	1000x36x1590	1200x36x1590	1400x36x1590	1600x36x1590
800x36x1790	1000x36x1790	1200x36x1790	1400x36x1790	1600x36x1790

With Velcro stripe | Avec bande Velcro | Mit einem Klettstreifen

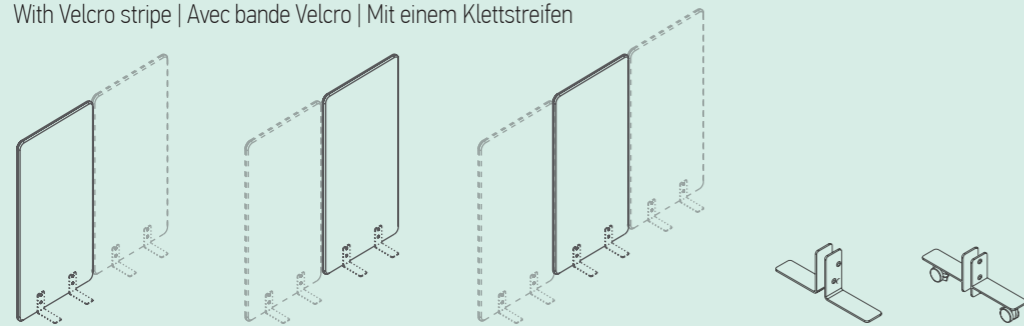

800x36x1190	1400x36x1190	1600x36x1190
800x36x1390	1400x36x1390	1600x36x1390
800x36x1590	1400x36x1590	1600x36x1590
800x36x1790	1400x36x1790	1600x36x1790

TOP 530



DESK 760



Acoustic furniture is made with sound-absorbing materials for noise reduction, separating workspaces and improving your concentration.

Les matériaux insonorisant utilisés dans les meubles acoustiques réduisent le bruit et décomposent les espaces, et permettent une meilleur concentration.

Akustik-Mobiliar wird aus schallabsorbierenden Materialien gefertigt, die den Geräuschpegel im Raum reduzieren und dadurch das Konzentrieren auf die Arbeit erleichtern.

TOP 530

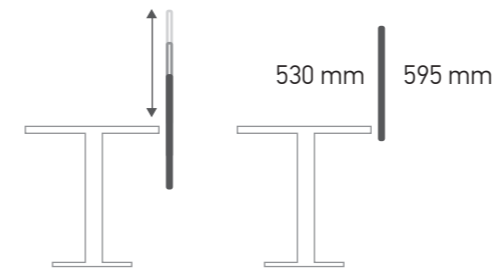

DESK 760

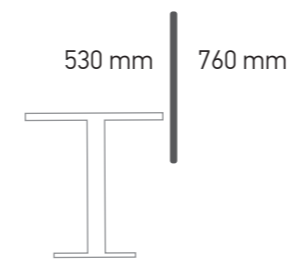

MODUS

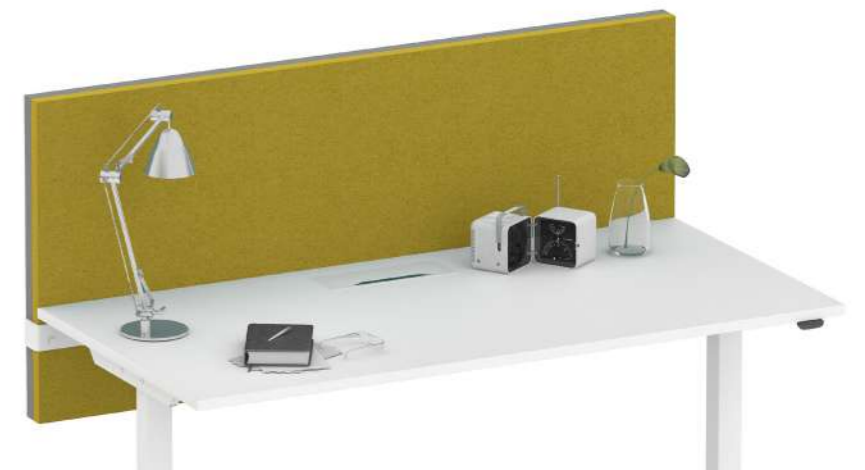
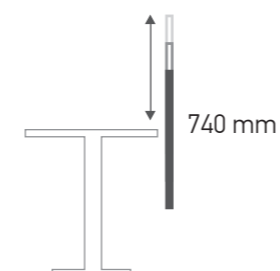



Acoustic furniture

Meubles acoustiques | Akustisch-wirksame Möbel

MY SPACE

JAZZ Silent Box



Acoustic panels

Panneaux acoustiques | Akustisch-wirksame Paneele

MODUS

FREE STANDING

Sound-absorbing acoustic screens not only separate your workspace from noisy office environment, but also help you to create distinct, colorful office spaces. Portable screens are easily movable all around the office.

La cloison acoustique absorbe le son environnant, elle ne protège pas seulement du bruit mais permet également de créer des zones colorées distinctes dans le bureau. Ces cloisons mobiles sont facilement maniables et intégrables dans l'espace de travail.

Die schallabsorbierende Trennwand hält nicht nur Geräusche fern, sondern bietet auch die Möglichkeit, verschiedenfarbige Zonen in Ihrem Büro zu schaffen. Die mobilen Trennwände lassen sich mühelos verschieben.



MY SPACE

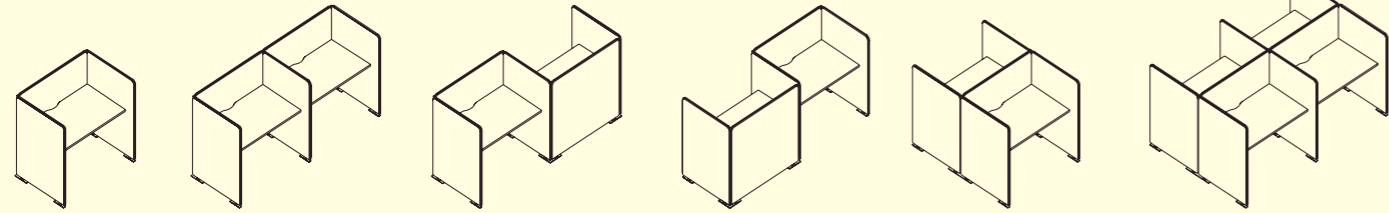

1072x1018x1270	2108x1018x1270	2108x1018x1270	2108x1018x1270	1072x2000x1270	2108x2000x1270
1272x1018x1270	2408x1018x1270	2408x1018x1270	2408x1018x1270	1272x2000x1270	2408x2000x1270
1472x1018x1270	2908x1018x1270	2908x1018x1270	2908x1018x1270	1472x2000x1270	2908x2000x1270
1672x1018x1270	3308x1018x1270	3308x1018x1270	3308x1018x1270	1672x2000x1270	3308x2000x1270

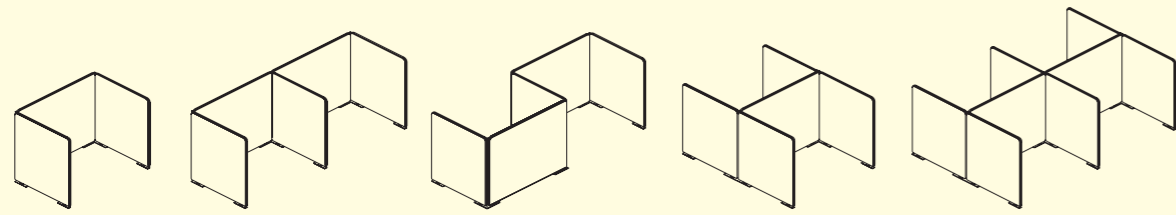

1472x848x1270	2908x848x1270	2908x848x1270	1472x1660x1270	2908x1660x1270
1472x1018x1270	2908x1018x1270	2908x1018x1270	1472x2000x1270	2908x2000x1270
1672x848x1270	3308x848x1270	3308x848x1270	1672x1660x1270	3308x1660x1270
1672x1018x1270	3308x1018x1270	3308x1018x1270	1672x2000x1270	3308x2000x1270

JAZZ Silent Box

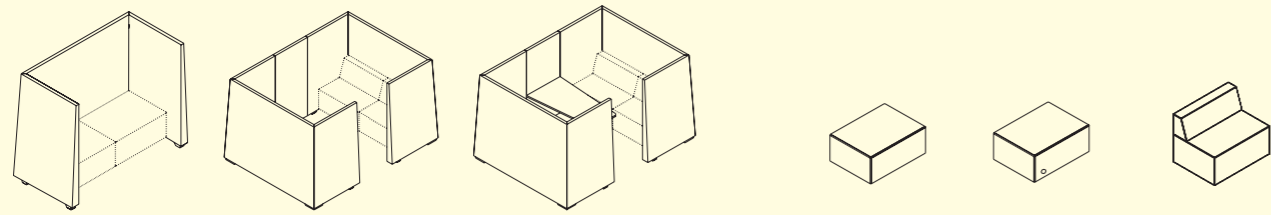

1810x925x1420	2500x1810x1420	2500x1810x1420	800x600x400	800x600x400	800x600x650
---------------	----------------	----------------	-------------	-------------	-------------

MODUS

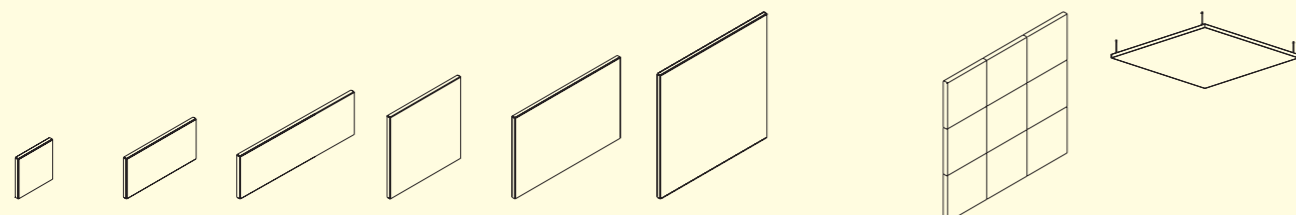

400x40x400	800x40x400	1200x40x400	800x40x800	1200x40x800	1200x40x1200
400x70x400	800x70x400	1200x70x400	800x70x800	1200x70x800	1200x70x1200

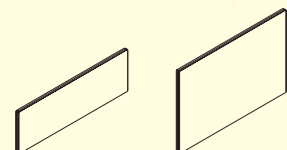

1200x46x400	1200x46x800
-------------	-------------



MY SPACE

MY SPACE perfectly absorbs noise and divides your office into personal workspaces. You can choose from MY SPACE with either a mounted desktop or only a screen that matches your table.

Les mobiliers acoustiques permettent simultanément : d'absorber les sons ainsi que de diviser les espaces de travail. Vous pouvez choisir MY SPACE avec plan de travail déjà intégré ou uniquement la cloison adaptée à votre bureau existant.

Das vielseitige Akustikmöbelsystem MY SPACE wirkt schalldämpfend und teilt zugleich den Arbeitsraum. Die Variante MY SPACE verfügt über bereits montierten Arbeitsplattem, aber Sie können auch eine einzelne Trennwand erhalten, um Sie an den vorhandenen Arbeitstisch anzufügen.



MY SPACE

MODUS



Acoustic panel system is a modern way to reduce noise in the office. It absorbs sound, divides spaces and completes interior.

Les panneaux acoustiques sont une façon moderne de réduire le bruit dans un bureau. Ils absorbent les sons, divisent l'espace et remplissent l'intérieur.

Akustikpaneele – die moderne Art und Weise den Rausch zu reduzieren. Mit diesem Akustiksystem kann man den Schall absorbieren, Räume teilen und als optisch ansprechendes Design-Element den Innenraum ergänzen.



JAZZ Silent Box

It is a peaceful zone at your noisy office environment. JAZZ Silent Box is perfect for individual work, short meetings or for taking breaks during the day.

Une zone de silence dans votre espace de travail. Espace pour un travail individuel ou pour les loisirs.

Die Ruhezone in Ihrer Arbeitsumgebung. Für individuelles Arbeiten, aber auch zum Ausruhen.



Cabinets

Armoires de bureau | Schränke

CHOICE

JAZZ

LIGHT

NOVA Basic

NOVA Line

UNI

UNI Slide

UNI Plus

Towers

Caissons hauts | Apothekenschränke

JAZZ

NOVA

LIGHT

Pedestals

Caissons | Rollcontainer

NOVA

OPTIMA

JAZZ



CHOICE

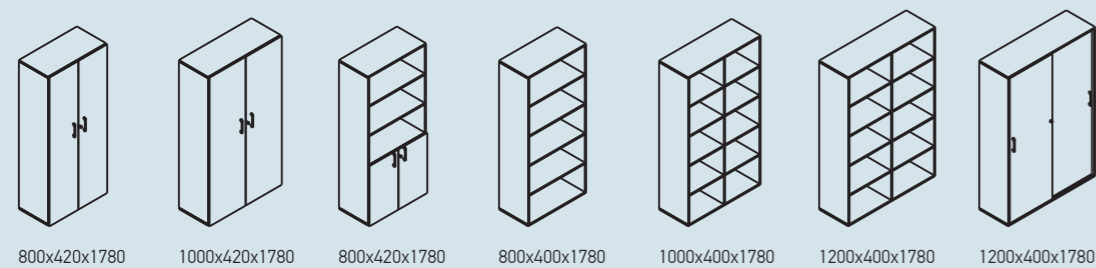
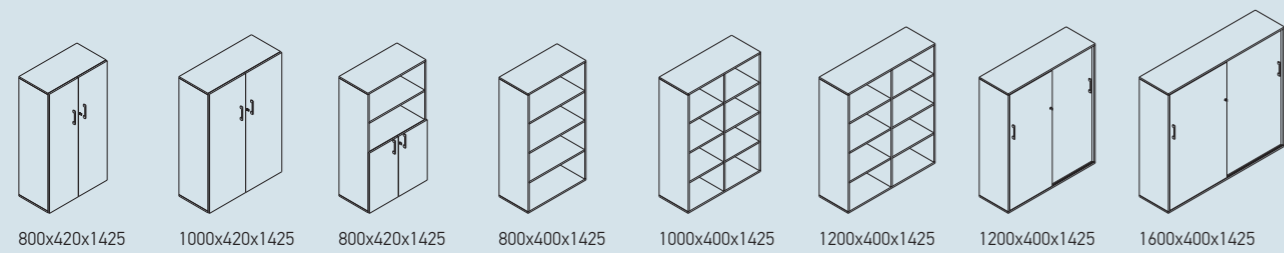
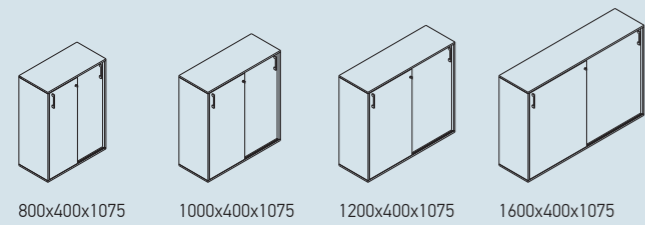
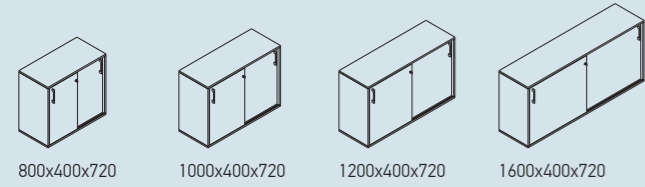
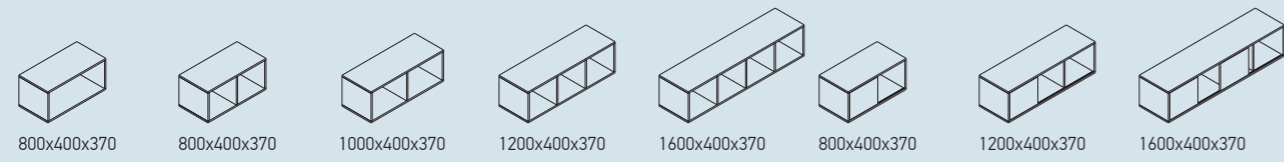

JAZZ

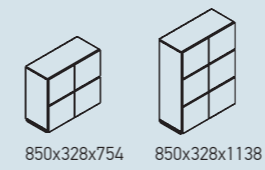

LIGHT

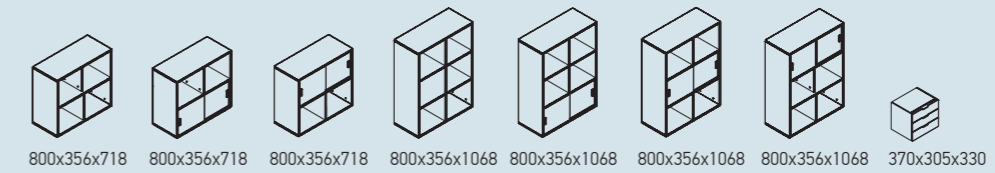

NOVA Basic

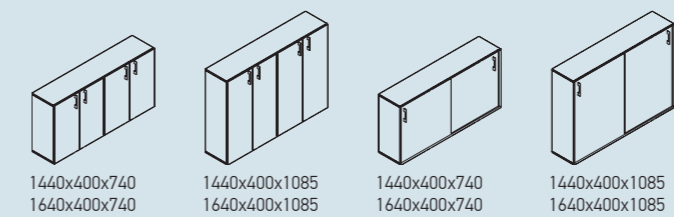
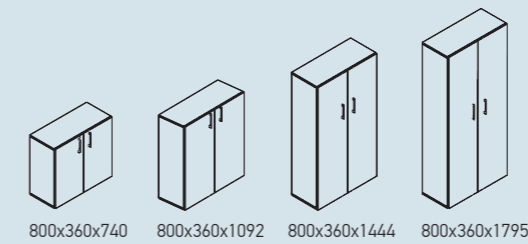
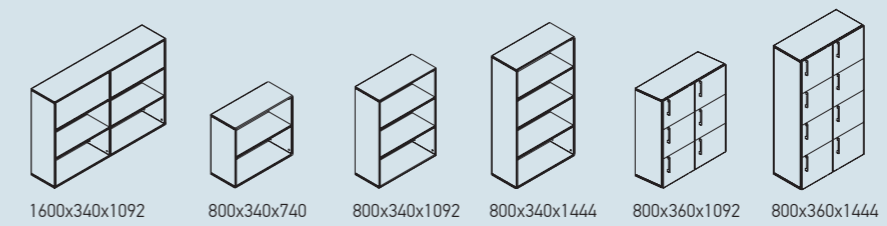

NOVA Line

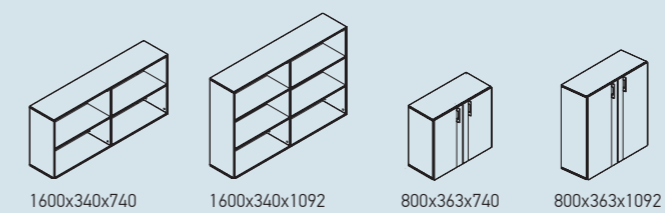

UNI

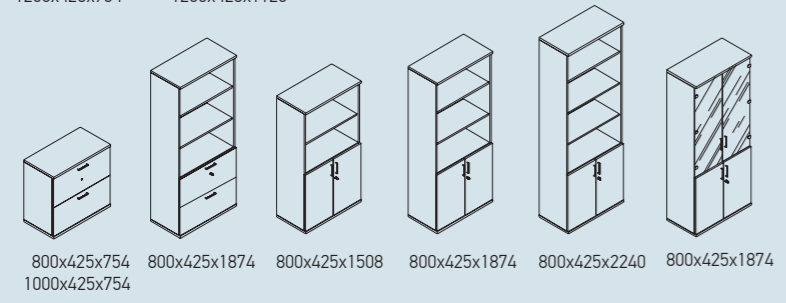
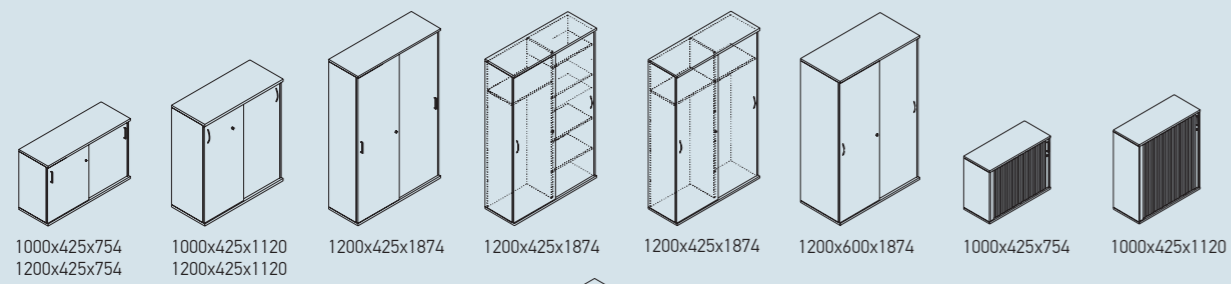
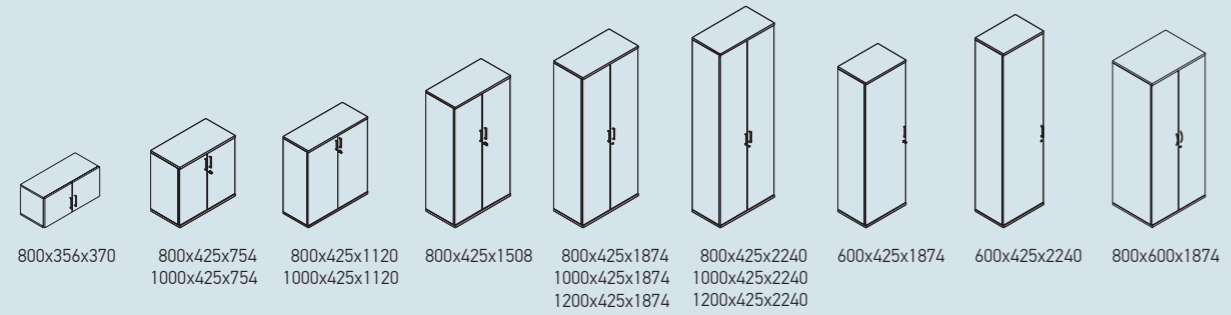
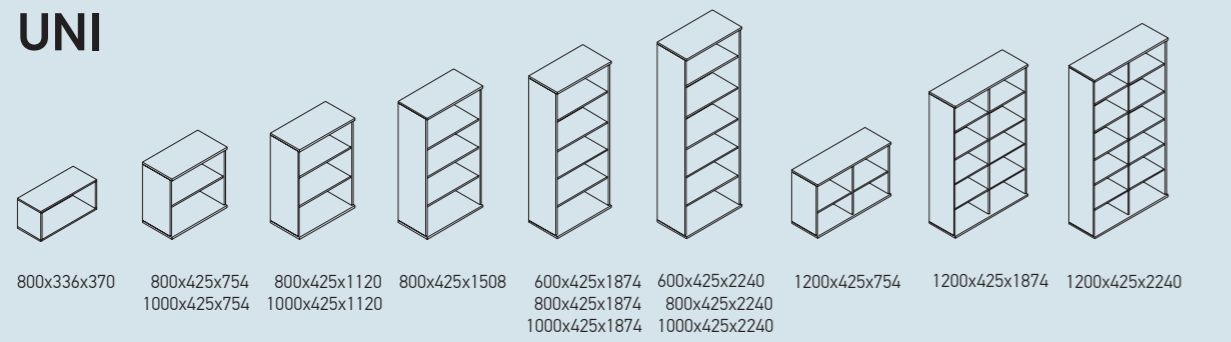

UNI Slide

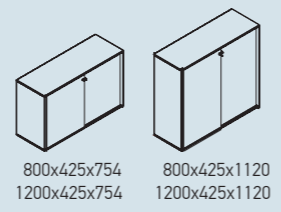

UNI Plus

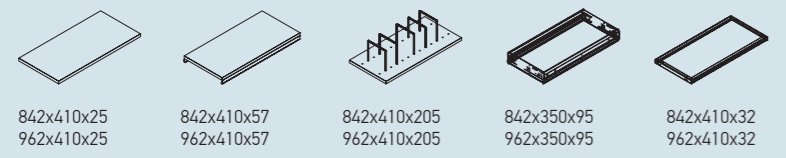
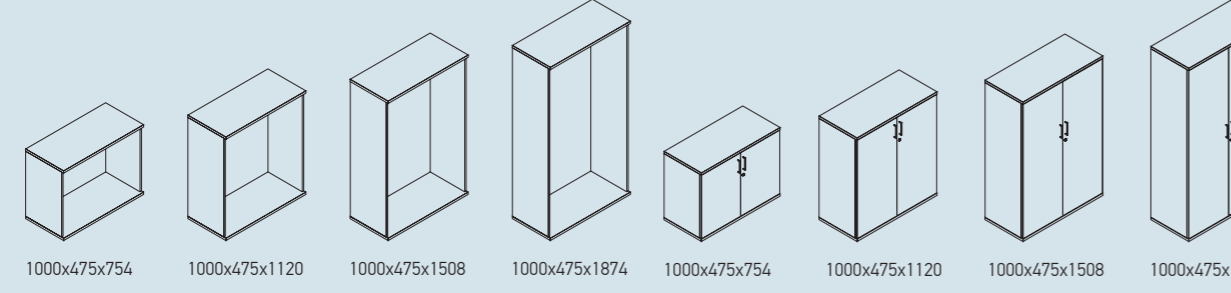
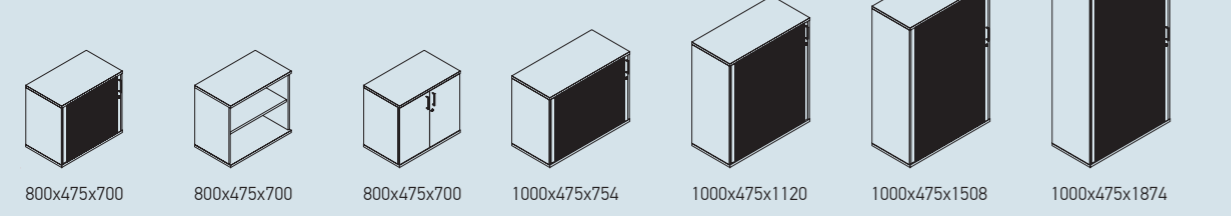

CHOICE

CHOICE





UNI

This exclusively wide range of cabinets allows you to choose from shelves of different heights and widths, paired with different types of possible cabinet doors. Backs of the cabinets may be covered in whiteboard or in fabric for sound absorption.

Caractérisées par une large palette d'armoires permettant de choisir parmi des étagères de différentes hauteurs et largeurs avec différents types de portes. Le dos peut être recouvert de tapisseries absorbant le bruit, ou de tableaux blancs pour écrire.

Ein besonders breites Schranksystem, das die Wahl zwischen Regalen verschiedener Höhen und Breiten sowie verschiedenen Arten von Türen bietet. Die Rückenwand kann mit schallabsorbierendem Stoff verkleidet oder einer weißen Schreibtafel ausgestattet werden.





UNI Plus

A universal storage system created for easy document archiving. There is a wide range of cabinets in different height and width: bookcases, cabinets with doors, cabinets with tambour doors, desk cabinets.

UNI PLUS est un système universel de rangement créé pour un archivage facile des documents. Il y a une grande gamme de meubles de rangement de hauteurs et de largeurs différentes: bibliothèques, meubles de rangement avec portes, meubles de rangement avec portes tambour, armoires de bureau.

UNI PLUS ist ein universales Stauraumsystem zur Archivierung von Dokumenten, Ordern oder Hängeregistern. Hierbei gibt es viele unterschiedliche Höhen und Breiten von: Regalen, Aktenschränken mit Türen, Aktenschränken mit Querrollade oder Schiebetür, Roll- oder Standcontainern.

You can choose conventional shelves, shelves with dividers and fixed or pull out filing cradles for hanging the files. All accessories are suitable for UK and EU standards.

Vous pouvez choisir des étagères conventionnelles, des étagères avec séparateurs et des paniers fixes ou à tirer. Tous les accessoires sont compatibles avec les normes anglaises et de l'UE.

Sie können herkömmliche Regale, Regale mit Teilern und fixierten oder ausziehbaren Hängeregistern wählen. Sämtliches Zubehör erfüllt die Standards der EU und UK.





UNI Slide

Cabinets with sliding doors. These capacious cabinets are made to store your work equipment and personal items.

Armoires de bureau avec des portes coulissantes. Ces armoires spacieuses sont faites pour y ranger votre matériel de travail et vos affaires personnelles.

Schränke mit sanftes Öffnen der Schiebetüren. In diesen räumigen Schränken können Sie Ihre Arbeitsmittel und persönliche Artikel aufbewahren.



LIGHT

This is a storage system that allows you to create your cabinet by choosing from many different colourful doors and drawers. There is always a possibility to choose different fabric colours for cabinet backs.

Système universel d'armoires de rangement. Permet de créer individuellement des combinaisons de portes et de tiroirs multi-couleurs. Il est possible de choisir des dos en tissus de différentes couleurs.

Ein vielseitiges Schranksystem, mit dem Sie Türen und verschiedenfarbige Schubladen nach eigenen Vorstellungen kombinieren können. Auch die Rückverkleidungen gibt es in verschiedenen Farben.

NOVA Line

Original cabinets, decorated with plexiglas inserts and handles. NOVA Line shelves and cabinets of different heights and widths will perfectly match any of our office furniture systems.

Armoires originales, décorées avec des inserts en plexiglas et des poignées. Les étagères et les armoires peuvent être de différentes hauteurs et largeurs, et s'accordent bien avec tout système de meubles de bureaux.

Schränke mit Einsätzen und Griffen aus organischem Plexiglas. Mit den offenen Regalen in verschiedenen Höhen und Breiten sowie den geschlossenen Schränken lassen sie sich gut mit verschiedensten Bürosystemen kombinieren.



NOVA Basic

Practical and functional high-capacity shelves and cabinets of different heights and widths can be easily combined in work environments to create various comfortable individual work areas.

Armoires de rangement fonctionnelles et de grande capacité, de différentes hauteurs et largeurs pour des profondeurs égales; étagères ouvertes ou armoires fermées, afin de créer des zones de travail communes ou individuelles.

Funktionelle und geräumige offene Regale einheitlicher Tiefe in verschiedenen Höhen und Breiten sowie geschlossene Schränke für gemeinsame und individuelle Arbeitsbereiche.



JAZZ

design by Christina Strand and Niels Hvass

Geometric shapes and perfectly straight lines create a sense of coherence.

Design aux formes géométriques, lignes droites apportant un sentiment d'harmonie.

Geometrische Formen und gerade Linien vereinen sich zu einem harmonischen Gesamtbild.



LIGHT



800x360x1090

NOVA



800x400x1090



800x400x1200



800x400x740

JAZZ



800x380x1156



NOVA



DNF632 428x600x560 |2|4|
 DNF633 298x600x560 |2|4|
 DNF626 428x600x560 |2|4|7|
 DNF627 298x600x560 |2|4|7|
 DNF642 430x600x740 |2|4|
 DNF636 430x600x740 |2|4|7|
 DNF422 428x600x410 |2|4|



DNF530 436x600x520 |1|4|
 DNF531 436x600x520 |1|3|4|

OPTIMA



PSR540 415x500x638 |1|10|
 PSR541 415x500x638 |1|4|10|
 PSR535 415x500x638 |1|4|7|10|
 PSR532 415x500x510 |1|4|10|
 PSR525 415x500x510 |1|4|7|10|
 PUR636 430x600x600 |2|4|9|
 PUR642 430x600x600 |2|4|5|8|9|
 PUR637 430x600x672 |2|4|7|9|



PSS642 415x600x720 |1|4|9|
 PSS637 415x600x720 |1|4|7|9|
 PUS642 415x600x720 |2|4|8|9|
 PUS635 430x600x720 |2|4|6|9|
 PUS835 415x800x720 |2|4|6|8|9|
 PSS837 415x800x720 |1|4|7|9|



PEX627 500x600x720 |1|4|7|8|9|
 PEX637 500x600x1020 |1|4|7|8|9|
 PEX647 500x600x1320 |1|4|7|8|9|
 PSP525 415x500x446 |1|4|7|
 PSP532 415x500x446 |1|4|7|
 DGF630 294x600x590 |1|4|7|8|

JAZZ



DGF630 294x600x590 |1|4|7|8|

- |1| Foil wrapped drawers
- |2| Metal-sided drawers
- |3| Silent closing mechanism
- |4| Central locking
- |5| First pencil drawer
- |6| File drawer
- |7| Full extension file drawer suitable for A4 or foolscap filing
- |8| Anti-tilt mechanism
- |9| Top 25 mm
- |10| Top 16 mm

- |1| Tiroirs avec côtés MDF
- |2| Tiroirs côtés métalliques
- |3| Mécanisme de fermeture silencieux
- |4| Fermeture principale
- |5| Tiroir pour accessoires de bureau
- |6| Tiroir pour classeurs suspendus
- |7| Tiroir pour classeurs suspendus à extension totale
- |8| Mécanisme « Anti-tilt »
- |9| Dessus 25 mm
- |10| Dessus 16 mm

- |1| Schubladen mit MDP-Seiten
- |2| Schubladen mit Metallseiten
- |3| Soft close
- |4| Zentralverriegelung
- |5| Schublade für Schreibutensilien
- |6| Schublade mit Hängeregistern
- |7| Bis zum Anschlag herausziehbare Schublade mit Hängeregistern
- |8| „Anti-Tilt“-Mechanismus
- |9| Deckel 25 mm
- |10| Deckel 16 mm

Meeting tables

Tables de réunion | Besprechungstische



- NOVA
- FORUM
- T-EASY
- AIR
- JAZZ

High tables

Tables hautes | Hochtische

- JAZZ
- NOVA
- LIGHT

Media units

Panneau Media | Media-wand

- MEDIA

Conference tables

Tables de conference | Konferenztische

- FLIP-TOP

Coffee tables

Tables basses | Niedriger Beistelltisch

NOVA

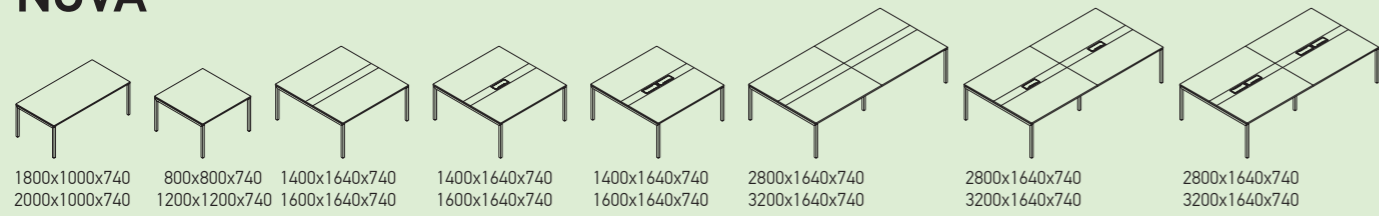

FORUM

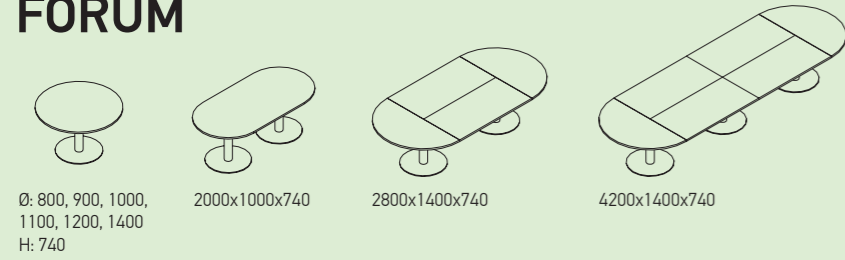

JAZZ

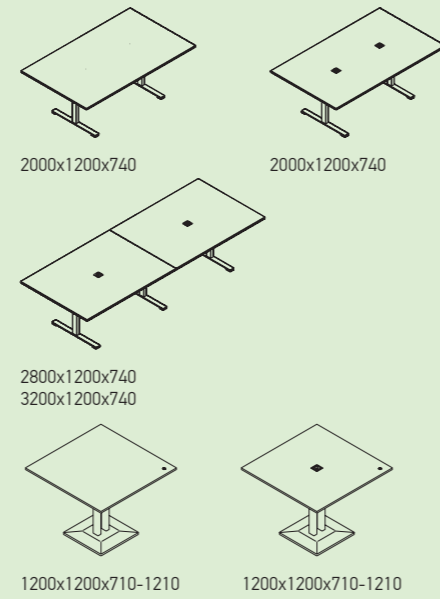

T-EASY

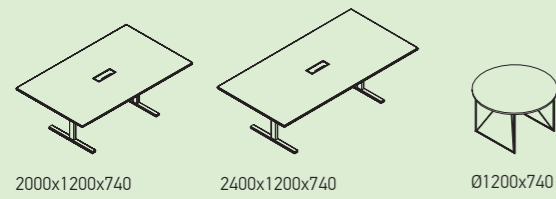

AIR

NOVA

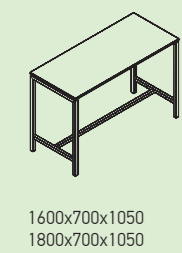

LIGHT

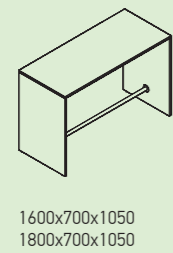

JAZZ

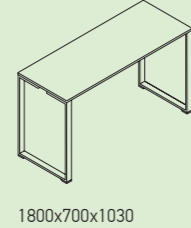

MEDIA

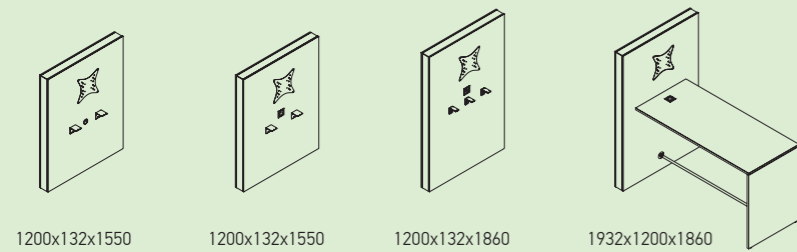

FLIP-TOP



FOLDING

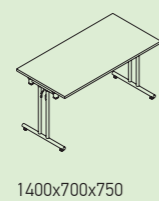

Coffee tables

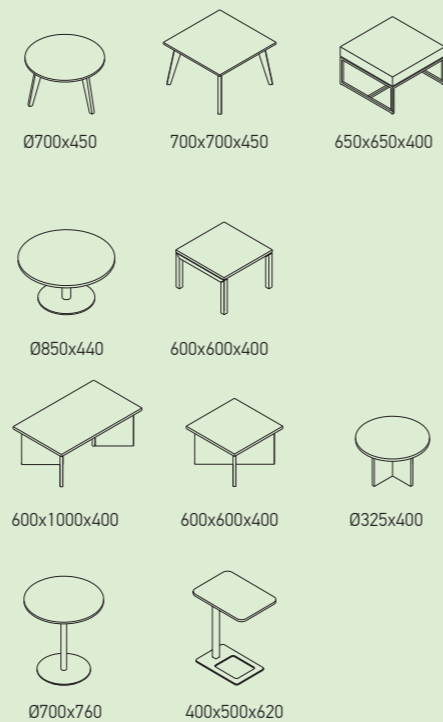

Tables of various sizes and shapes: rectangular or round, providing more comfort and productivity for your meetings. IT equipment wiring and power sockets are mounted under the tabletop.

De différentes tailles et formes : rectangulaires ou rondes, apportant intimité et confort pour les réunions. Des blocs spéciaux sous le plan de travail permettent de cacher les boîtes d'électricité et le câblage.

Verschiedene Größen und Formen - rechteckig oder rund – sorgen für eine familiäre Atmosphäre. Unter den Arbeitsplatten befinden sich Fächer für Stromversorgung und Kabel.





FORUM

Economic, very stable and durable. Round tabletops and bases for effective use of the entire table area and convenient communication with colleagues and partners. Big choice of various sizes to find the best solution that suits your needs.

Économiques, très stables et durables. Dessus de table et bases rondes pour une utilisation efficace de toute la surface de la table et pour une communication commode avec les collègues et partenaires. Grand choix de dimensions diverses pour trouver la meilleure solution convenant à vos besoins.

Kostengünstig, sehr stabil und langlebig. Runde Tischplatten und Tischfüße für die effiziente Nutzung des gesamten Tischbereichs und die komfortable Kommunikation mit Kollegen und Geschäftspartnern. Große Auswahl verschiedener Größen, um die beste Lösung zu finden, die am besten zu Ihren Bedürfnissen passt.



T-EASY

T-EASY stands for neutral aesthetic design. It perfectly blends into an existing working space and contributes to overall office interior. Goes well with EASY height adjustable tables.

Conception esthétique neutre. Ces tables s'intègrent parfaitement à un espace de travail existant. Complètent parfaitement les tables EASY.

Neutrales, ästhetisches Design, das sich hervorragend in jeden Arbeitsraum einfügt und ihn ergänzt. Wir empfehlen die Kombination mit höhenverstellbaren EASY Tischen.

AIR

design by Gediminas Juška

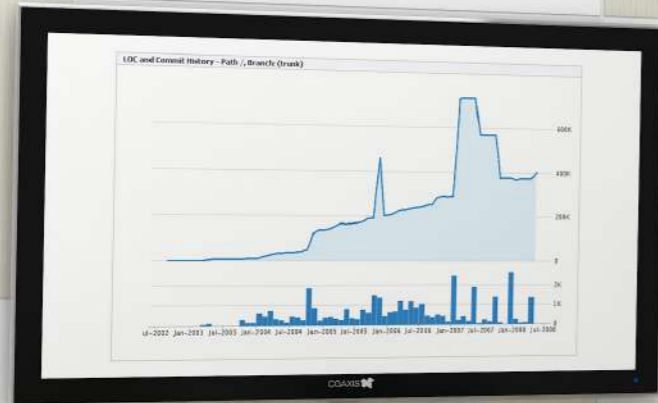



JAZZ

design by Christina Strand and Niels Hvass

Fixed height and precisely shaped meeting tables are created for teams of eight, ten or twelve people.

Tables de réunion de hauteur fixe, de formes précises et de différentes tailles : pour une équipe de huit, dix ou douze personnes.

Die klar und exakt geformten Konferenztische einheitlicher Höhe gibt es für acht, zehn und zwölf Personen.





JAZZ

design by Christina Strand and Niels Hvass

NOVA

Designed for leisure and quick meetings, high table NOVA with U-shaped legs goes in perfect harmony with NOVA furniture collection.

Les tables hautes NOVA dont les pieds sont en forme de U sont destinées à des zones de repos ou pour des courtes réunions. Elles complètent harmonieusement le système des meubles NOVA.

Für Ruhebereiche oder kurze Besprechungen eignen sich der Stehtische NOVA mit U-förmigen Beinen, die sich hervorragend in das NOVA-Möbelsystem einfügen.



LIGHT

High table LIGHT with flat table legs. Laconic style and design solutions go perfectly well with many different interiors.

Tables hautes LIGHT avec pieds panneaux. Leur forme épurée et leur conception permettent de les combiner avec différents types de solutions intérieures.

Die Stehtische LIGHT mit Paneelbeinen passen sich dank schlichter Form und Konstruktion mühelos an verschiedenste Interieurs an.





MEDIA

Smart solution to integrate today's technology into your meeting areas.

MEDIA est une solution intelligente pour intégrer la technologie d'aujourd'hui à vos aires de réunion.

MEDIA ist eine clevere Lösung, um die Technologie von heute in Ihre Besprechungsbereiche zu integrieren.



FLIP-TOP

Flip-top design allows you easily to change the tabletop position from horizontal to vertical. These tables are highly compact and easy to store.

Tables avec plan de travail rabattable : pouvant facilement passer d'une position horizontale à une position verticale. Elles peuvent donc être rangées ou stockées verticalement sans prendre beaucoup d'espace.

Die Arbeitsplatte können Sie horizontal oder vertikal kippen. Diese Tische lassen sich gut lagern und nehmen wenig Platz ein.



Coffee tables

Tables basses | Niedriger Beistelltisch



Executive furniture

Mobilier de direction | Chefzimmer

PLANA

AIR Executive

ZETA

NOVA Executive



PLANA

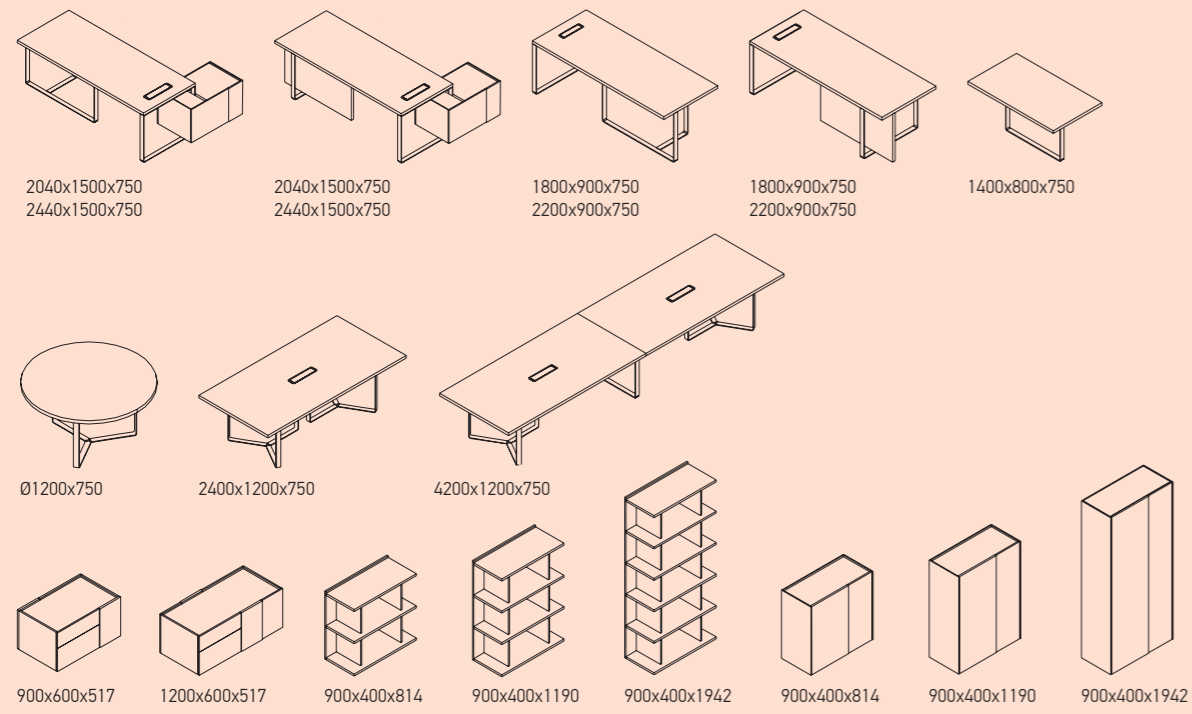

AIR Executive

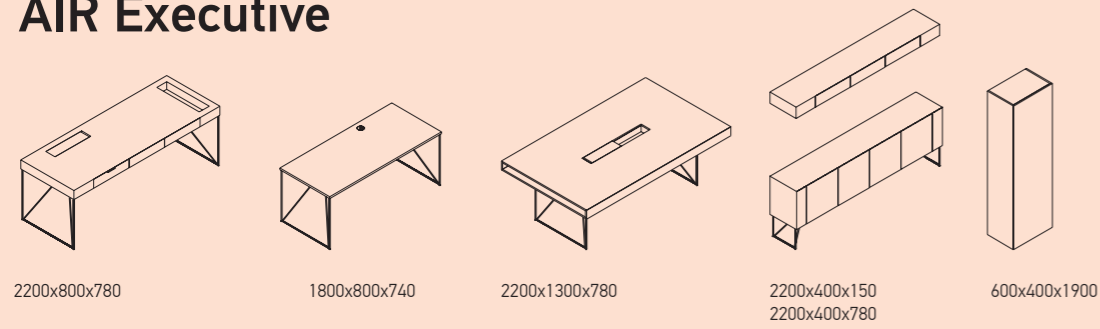

ZETA

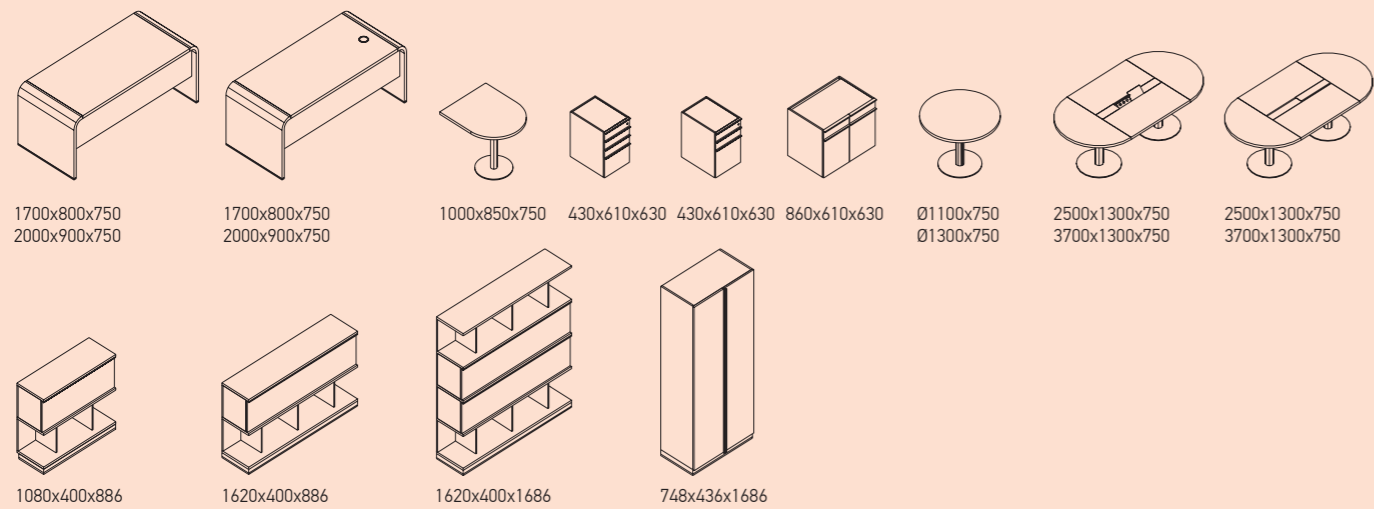

NOVA Executive

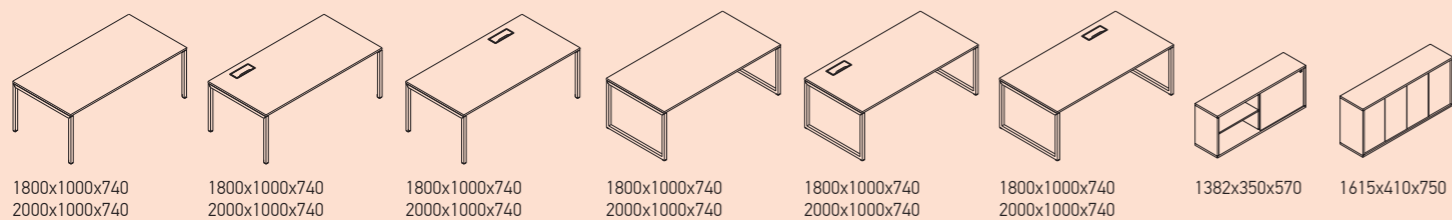

PLANA

design by Roberto Lucci & Paolo Pampanoni





PLANA

design by Roberto Lucci & Paolo Pampanoni

It is a modern high-quality furniture collection. Straight lines, smooth-running forms, warm, refined materials. Aesthetics and functionality create a sense of luxury.

Collection de meubles modernes et de haute qualité. Des lignes droites, des formes régulières, différentes épaisseurs, utilisation de matériaux raffinés. Solution pour une conception esthétique et fonctionnelle offrant un sentiment de luxe.

Eine moderne, besonders hochwertige Möbelkollektion. Gerade Linien, gleichmäßige Formen, unterschiedliche Stärken und warme, raffinierte Materialien. Das ebenso geschmackvolle wie funktionelle Design verströmt einen Hauch von Luxus.



AIR Executive

design by Gediminas Juška

The perfect combination of aesthetics and functionality. The essential part of AIR Executive is its natural wood veneer tabletop and steel legs that ensure not only the elegant feel of the table, but also its stability and solidity. Steel table legs are designed in a way so you could easily hide all the cable wiring and keep all the unnecessary items out of your main workspace.

Mélange offrant esthétique et fonctionnalité. Le plan de travail massif, en bois naturel, semble en sustentions dans l'air sur des pieds effilés en acier chromé. Les câbles Internet et électriques peuvent s'y faufiler offrant un bureau de responsable toujours propre.

Ästhetisch und funktional. Die massive, naturholzbeschichtete Arbeitsplatte auf den schlanken verchromten Stahlbeinen erscheint wie in der Luft schwebend. Die Beine eignen sich für Kabelführung und sorgen dafür, dass auf dem Tisch des Chefs stets Ordnung herrscht.





Expressive yet solid. Sleek table forms and open shelves together create a comforting feeling of space and mindfulness.

Expressif et solide. La forme aérodynamique de la table et des étagères ouvertes donne une agréable sensation de confort invitant à des réflexions et des idées nouvelles.

Massiv und eindrucksvoll. Die fließenden Formen des Schreibtisches und die offenen Regale geben dem Raum Weite, in der die Ideen ungehindert fließen können.





Reception furniture

Mobilier d'accueil | Empfangsmöbel

COSY

ICE

ICE Sit-stand

NOVA

TERA

NOVA Executive

Moderate minimalism and laconic lines. This collection is designed for democratic and modern executives, who appreciate the quality of the details and functionality in the work environment.

Minimaliste modéré, lignes épurées. Ceci est un mobilier conçu pour un chef moderne et à l'écoute, attentif aux détails, à la qualité et à la fonctionnalité de l'environnement de travail.

Verhaltener Minimalismus und schnörkellose Linien – die idealen Möbel für einen integrativen und modernen Chef, der hochwertige Details und Funktionalität in seiner Arbeitsumgebung zu schätzen weiß.

COSY

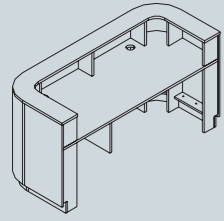

2000x800x1025

ICE

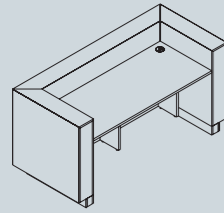

2000x900x1000

ICE Sit-stand

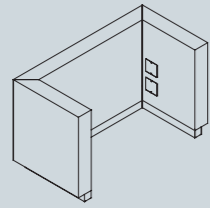

2020x1020x1200

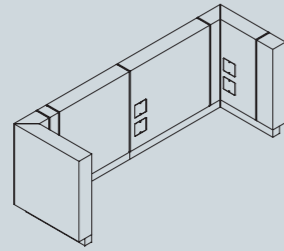

3230x1020x1200

NOVA

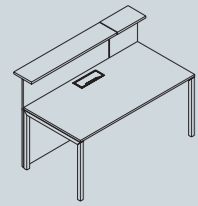

1600x935x1125
1800x935x1125

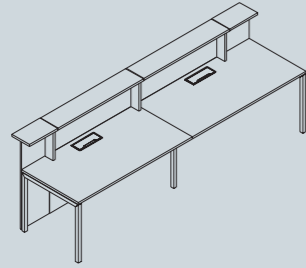

3200x935x1125

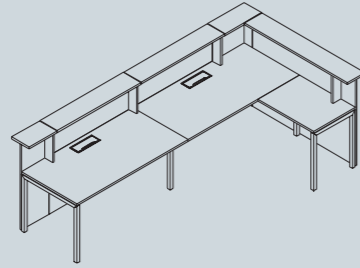

3340x1735x1125

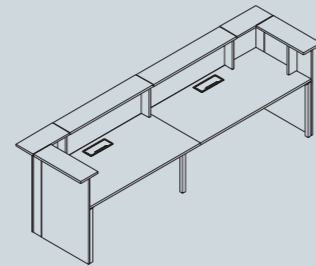

3470x935x1125

TERA

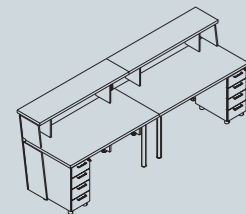

3000x893x1115

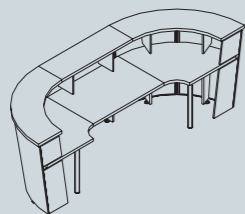

3350x1100x1115

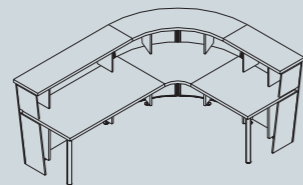

2600x2000x1115

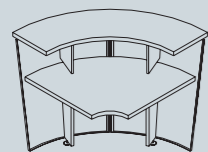

Ø1100x1115

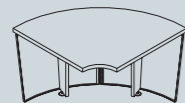

Ø1048x750

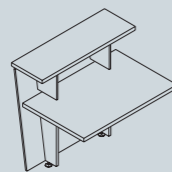

900x893x1115
1150x893x1115
1500x893x1115

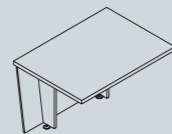

900x893x750
1150x893x750
1500x893x750



312x546x711



312x546x711

Reception



COSY

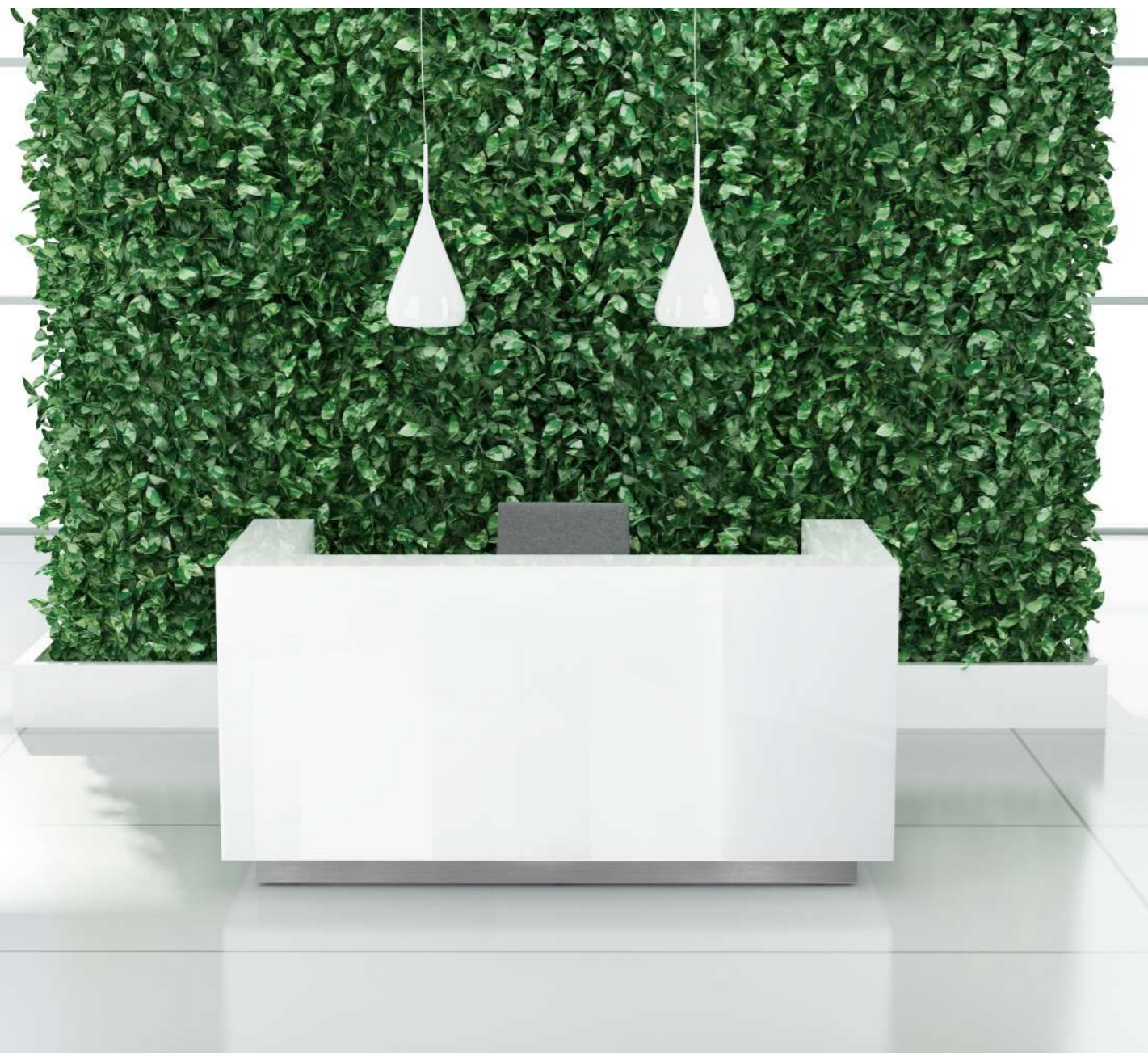

ICE

design by Kristina Zuokienė

Light, minimalist and purely geometric design. Precisely white and glossy ICE reception furniture attracts the eye and leaves a great first impression.

Léger et minimaliste, design aux formes géométriques propres. D'un blanc brillant et pur, les meubles d'accueil ICE créent l'impression d'exclusivité.

Leichtes, minimalistisches Design mit streng geometrischen Formen. Die strahlend weißen Empfangsmöbel ICE verleihen Ihren Büroräumen den gebührenden Glanz.

ICE Sit-stand





NOVA

Delight in its simplicity, NOVA reception furniture stands out with its exclusive decor detail – plexiglas inserts that compliment your office interior with a more elegant and unique feel.

Mobilier d'accueil qui fascine par sa simplicité et ses détails de décoration exclusifs : les inserts en plexiglas créent un intérieur de bureau élégant et unique.

Durch Einfachheit bestechendes Empfangsmobiliar mit exquisiten Dekor. Die Plexiglas-Einsätze lassen Ihre Büroräume besonders stilvoll erscheinen.



TERA

design by Vaidas Zabulionis

Stylish and elegant. By selecting different coatings and colors, you can create the perfect reception interior: moderate and minimalist or cozy and harmonious.

Élégant et raffiné. Possibilité de choisir différents revêtements et couleurs pour créer un accueil au style que l'on désire : sobre et minimaliste ou confortable et harmonieux.

Stilvoll und elegant. Wählen Sie verschiedene Bedeckungen und Farben, um Ihrem Empfangszimmer den gewünschten Stil zu geben: verhalten minimalistisch oder eher gemütlich.

Melamine | Mélamine | Melamin

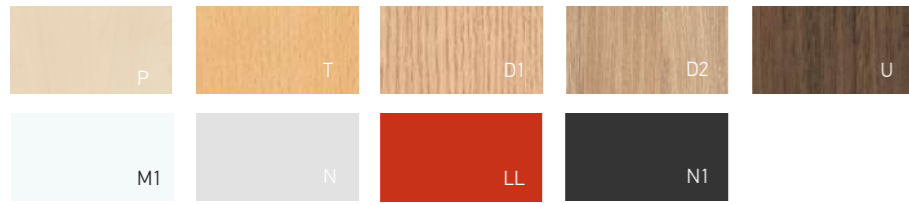

Veneer | Placage | Furnier



Veneer stained | Placage teinté | Furnier gebeizt



Plexiglas

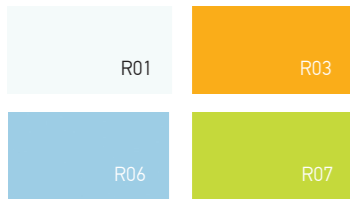

HPL | Stratifié | HPL



Metal | Métal | Metall



Painted metal | Couleur de métal | Lackiertes Metall

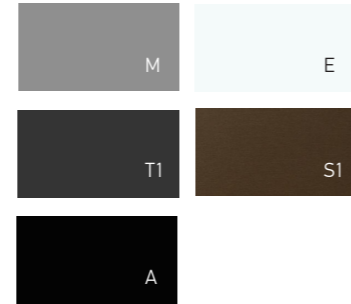

Enamel | MDF laqué | Enamel



Concrete | Béton | Beton



Synergy

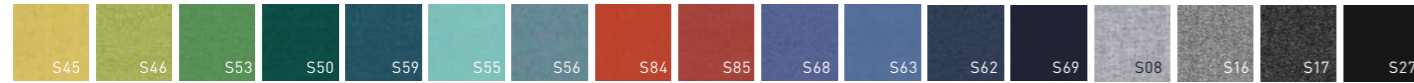

Velito | Velito Presto

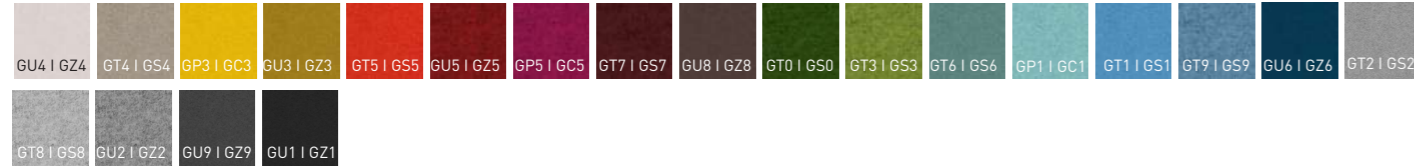

Blazer Lite

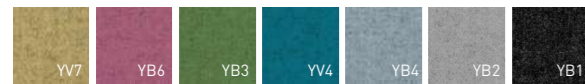

Twist



Berta



Era



Xtreme Plus | Lucia



Bondai



Please check our online pricelist for updates and full range of offered materials.
Veuillez consulter nos listes de prix en ligne pour accéder aux mises à jour et à la gamme complète de nos produits.
Bitte erkundigen Sie sich über unsere Online-Preisliste nach Aktualisierungen und der gesamten angebotenen Produktpalette.

EN
FR
DE

narbutas

Narbutas Furniture Company, UAB | Phone: +370 5 210 7922 | Šeškinės st. 55A, 07159 Vilnius, Lithuania | www.narbutas.com