

BAUX IS FOUNDED
ON THE BELIEF
THAT BUILDING
MATERIALS SHOULD
BE SUSTAINABLE,
SURPRISINGLY
FUNCTIONAL AND
REMARKABLY
BEAUTIFUL.

LET'S BUILD!



Wood wool is a functional, natural material.

BAUX Acoustic Wood Wool is made from two of the world's oldest building materials, wood and cement.

The combination is simple and ingenious. Wood fibre offers excellent insulation, heat retention and sound absorption. Cement, a proven and popular building material, is the binder that provides strength, moisture resistance and fire protection. Therefore, BAUX Acoustic products are versatile and durable in all climates.

ACOUSTIC TILES

SQUARE

Large: 2.97 tiles/m², 0.28/sq.ft.
Small: 11.82 tiles/m², 1.10/sq.ft.
25 mm thick, 1,0"



RECTANGLE

Large: 1.49 tiles/m², 0.14/sq.ft.
Small: 5.95 tiles/m², 0.55/sq.ft.
25 mm thick, 1,0"



CIRCLE

Large: 3.78 tiles/m², 0.35/sq.ft.
Small: 15.14 tiles/m², 1.41/sq.ft.
25 mm thick, 1,0"



TRIANGLE

Large: 5.95 tiles/m², 0.55/sq.ft.
Small: 23.78 tiles/m², 2.21/sq.ft.
25 mm thick, 1,0"



HEXAGON

Large: 4.45 tiles/m², 0.41/sq.ft.
Small: 17.82 tiles/m², 1.66/sq.ft.
25 mm thick, 1,0"

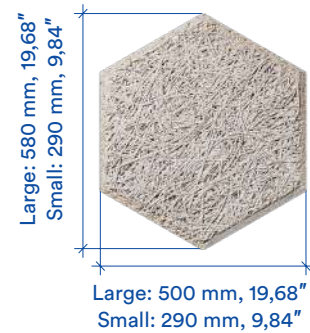

PARALLELOGRAM

Large: 2.97 tiles/m², 0.28/sq.ft.
Small: 11.89 tiles/m², 1.10/sq.ft.
25 mm thick, 1,0"



QUARTER CIRCLE

Large: 2.97 tiles/m², 0.28/sq.ft.
Small: 11.82 tiles/m², 1.10/sq.ft.
25 mm thick, 1,0"

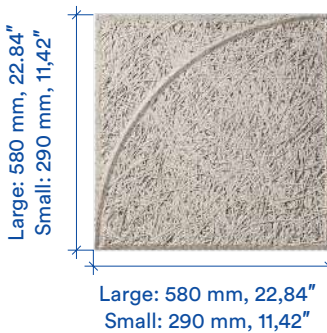

PLANK

Large: 2.97 tiles/m², 0.28/sq.ft.
Small: 11.89 tiles/m², 1.10/sq.ft.
25 mm thick, 1,0"



ACOUSTIC PANELS

QUILTED

1.49 panel/m², 0.14/sq.ft.
25 mm thick, 1,0"



STRIPES

1.49 panel/m², 0.14/sq.ft.
25 mm thick, 1,0"



DIAGONAL

1.49 panel/m², 0.14/sq.ft.
25 mm thick, 1,0"

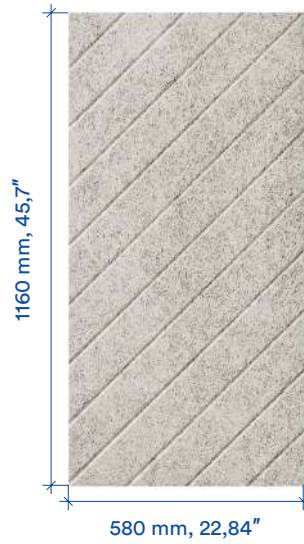

LINES

1.49 panel/m², 0.14/sq.ft.
25 mm thick, 1,0"



CHECK

1.49 panel/m², 0.14/sq.ft.
25 mm thick, 1,0"



ARCH

1.49 panel/m², 0.14/sq.ft.
25 mm thick, 1,0"



CURVE

1.49 panel/m², 0.14/sq.ft.
25 mm thick, 1,0"



ACOUSTIC CEILING

PINSTRIP

25 mm thick, 1,0"



WIDESTRIPE

25 mm thick, 1,0"



FLAT

25 mm thick, 1,0"



3D PIXEL

11.9 tiles/m², 1.10/sq.ft.

70

70 mm thick, 2,75"



70

70 mm thick, 2,75"

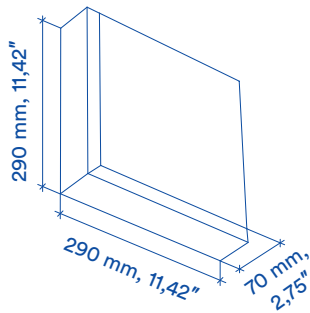

50

50 mm thick, 1,96"

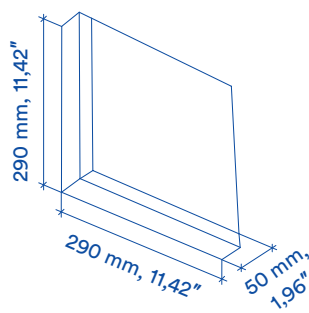

25

25 mm thick, 1,0"

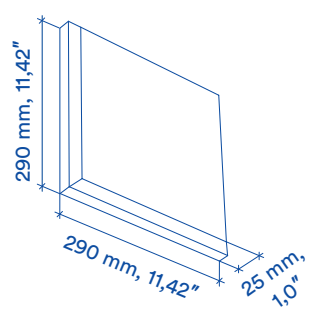



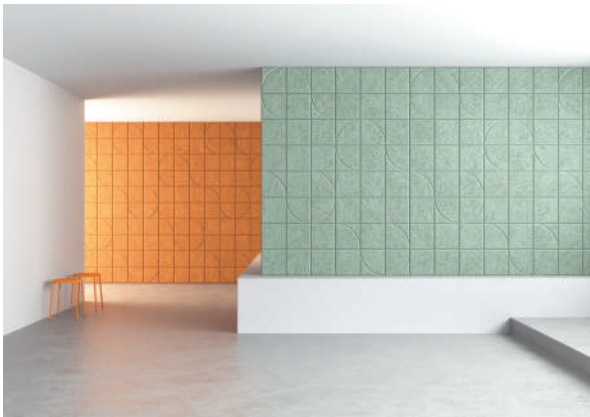



COLOUR SCHEME

CLOUDS

WOODS

SKY IN THE SEA

HEAT OF THE SUN

EARTH AND MOUNTAIN

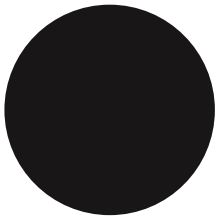

Clouds Black

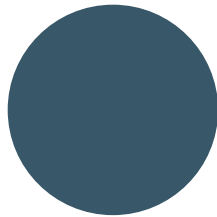

Woods Pine Green

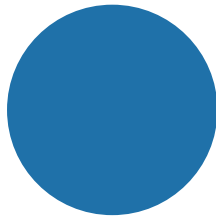

Sky Navy Blue

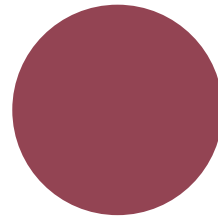

Heat Clay Red

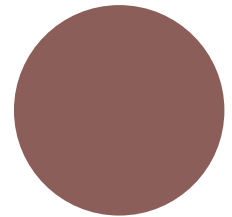

Earth Soil Brown

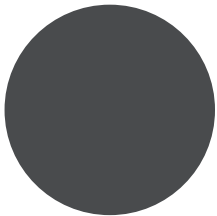

Clouds Dark Grey

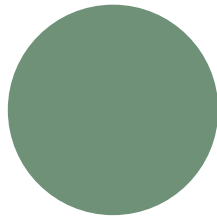

Woods Moss Green

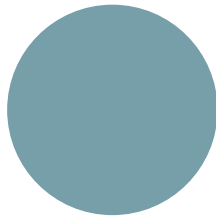

Sky Antique Blue

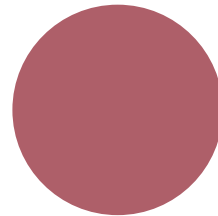

Heat Rust Red

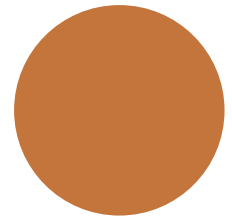

Earth Brown

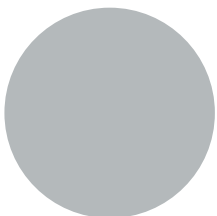

Clouds Grey

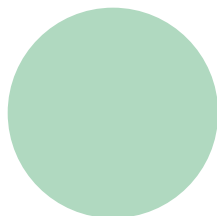

Woods Bright Green

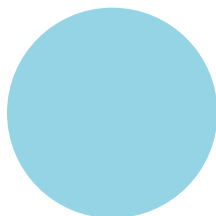

Sky Day Blue

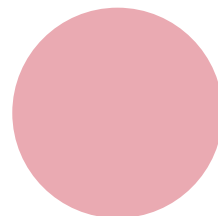

Heat Skin Red

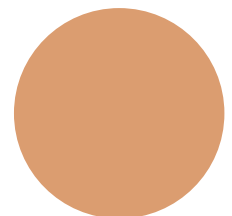

Earth Sand Brown

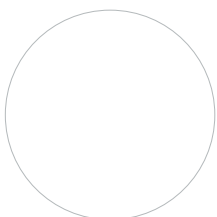

Clouds White



Woods Pale Green

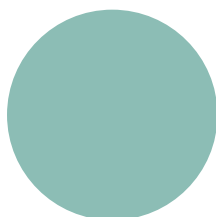

Sky Dusk Blue

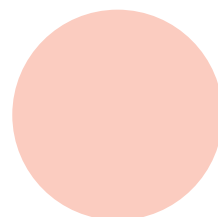

Heat Peach Red

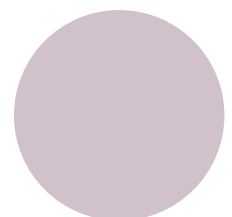

Earth Dust Brown



Custom Colours available upon request



Also available unpainted/Natural

BAUX PATTERNS



BAUX Patterns makes it simpler than ever to transform any space with a unique BAUX design. Browse through our Pattern collections and choose from over 500 designs. All free to download!

Each pattern is designed to repeat like wallpaper so you can quickly calculate how many tiles you need for your wall or space. All patterns include 3d architectural files.

Browse the full patterns library on www.baux.com/patterns.

SOUND

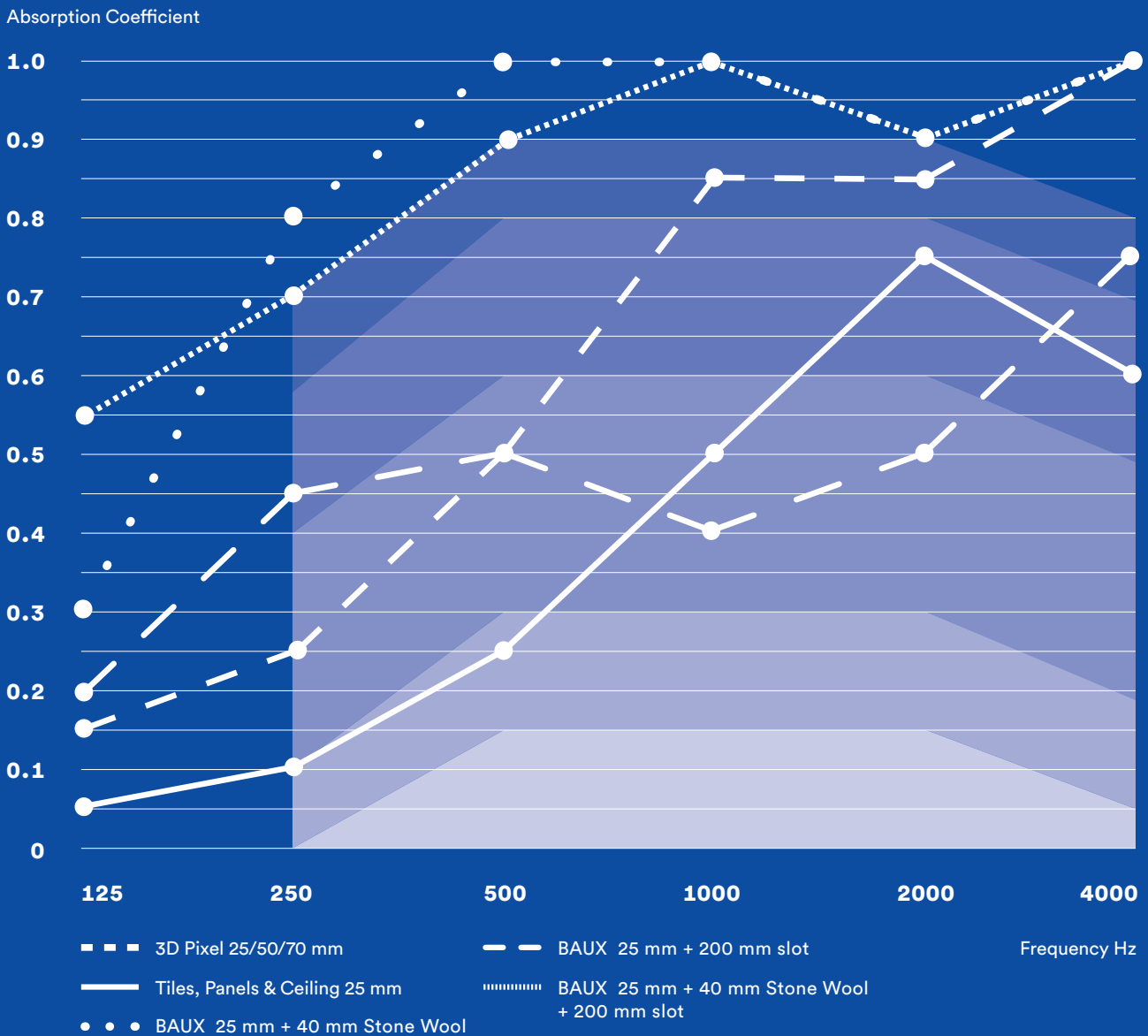

This graph shows the practical absorption coefficient of BAUX Acoustic Wood Wool at any given audio frequency.

The material structure of BAUX Acoustic products reduces sound reflections, making it a great sound absorber. The material dampens noise and contributes to restful acoustics in residential buildings, industrial premises and public spaces.

INFO@BAUX.COM
WWW.BAUX.COM

BAUX