

BAUX

Acoustic Wood Wool

BAUX IS FOUNDED
ON THE BELIEF
THAT BUILDING
MATERIALS
SHOULD BE
SUSTAINABLE,
SURPRISINGLY
FUNCTIONAL AND
REMARKABLY
BEAUTIFUL.

LET'S BUILD!



A square table with a decorative wooden top featuring a geometric pattern of triangles and squares in various shades of brown and tan. The table is supported by four white legs. On the opposite side of the table is a whiteboard with a thin wooden frame and a small desk lamp.

A square table with a decorative wooden top featuring a geometric pattern of triangles and squares in various shades of brown and tan. The table is supported by four white legs. On the opposite side of the table is a whiteboard with a thin wooden frame and a small desk lamp.

BAUX

Acoustic Wood Wool

| | |
|--------------------------------|----------------|
| Born from our values | 8-15 |
| BAUX Acoustic Wood Wool | 16-31 |
| Product assortment | 32-87 |
| Colour collection | 88-101 |
| Acoustics | 102-113 |
| Create your design | 114-121 |
| Inspiration | 122-137 |
| Specifications | 138-146 |

BORN FROM OUR VALUES



When we're looking for new designs, products or acoustic materials, nature is always our first source of inspiration.

It all started with a simple idea. That acoustic materials can be the bridge that connects urban architecture and interior design with nature. A perfect harmonization of beauty, function and sustainability, without compromise. This idea energizes us daily. It's embedded in the products we make and the way we do business. And it pushes us to constantly strive to do better, and more.

For us, BAUX is the sum expression of what we do, what we stand for, and what makes us relevant. Our mission is to change the world for the better.

With acoustical products? Yes. After all, a conversation between two students excels into brilliance, a business meeting gone right leads to new potential or leaders of nations make an agreement that matters to the world – all thanks to restful acoustics in residential buildings, industrial premises and public spaces.

Headquartered in Stockholm, Sweden, BAUX is only a short commute away from a quiet walk on a forest trail or a swim in a tranquil lake. A perpetual invitation to put down our laptops, detach from the office and reawaken the depths of our inborn senses.

Nature offers a sanctuary far from the noise, bustle and stimulation of urban life. A restful and soothing space where you can quiet your mind and tune into something deeper. Feel the brush of wind on your ears. Breathe in the scent of earth and pine. Listen to the chirping of birds or the rushing of water. Feed your eyes with a restorative palette of greens, browns and blues.

It's no surprise that nature is always our first source of inspiration whenever we're looking for new designs, products or materials. Not only does it provide a wellspring of ideas for colours, patterns and shapes. When you explore beneath the surface, nature holds the key to removing unsustainable ingredients from the equation entirely.

At BAUX, we're constantly seeking to uncover potential, inspire change and discover new ways to make people's lives at work better through sustainable acoustical solutions. It's our passion. And it's firmly rooted in the belief that our products should do more than serve as a functional solution or meet the contemporary design expectations of architects and engineers. They should also contribute to a better planet, both today and for generations to come.

It's simply a matter of wanting to change things for the better.

The degradation of our natural environment is a global topic of increasing urgency, and we can no longer afford to turn our backs or cut corners. We are dedicated to doing our part to reduce our ecological footprint and make sustainability an integral part of everything we do and create. Preventing pollution, reducing waste, conserving resources, designing for longevity. Learning from our mistakes, asking the right questions and always striving to do things even better than before.

We believe in a future where companies are founded upon strong values that direct industries towards a sustainable future. Where businesses guide customers in the right direction. And brands you can trust create products and services that work with nature—not against it.

But dreams, ideas and prototypes forecasted for some point in the future are not enough. We need working solutions today.

The tools and inspiration already exist, and the possibilities are truly exciting. It's simply a matter of wanting to change things for the better.

Let's build!



Petrus Palmér Johan Ronnestam Fredrik Franzon Jonas Pettersson John Löfgren





BAUX ACOUSTIC WOOD WOOL

**A FUNCTIONAL
AND NATURAL
MATERIAL.**



The ingredients:

Wood

Water

Cement





Sustainable

Sound absorbing

Fire resistant

Moisture regulating

Heat accumulating

Made in Sweden



BAUX Acoustic Wood Wool is made from two of the world’s oldest building materials: wood and cement. The combination is simple and ingenious.

Wood fibre offers excellent insulation, heat retention and sound absorption.

Cement, a proven and popular building material, is the binder that provides strength, moisture resistance and fire protection.

Therefore, BAUX Acoustic products are versatile and durable in all climates.

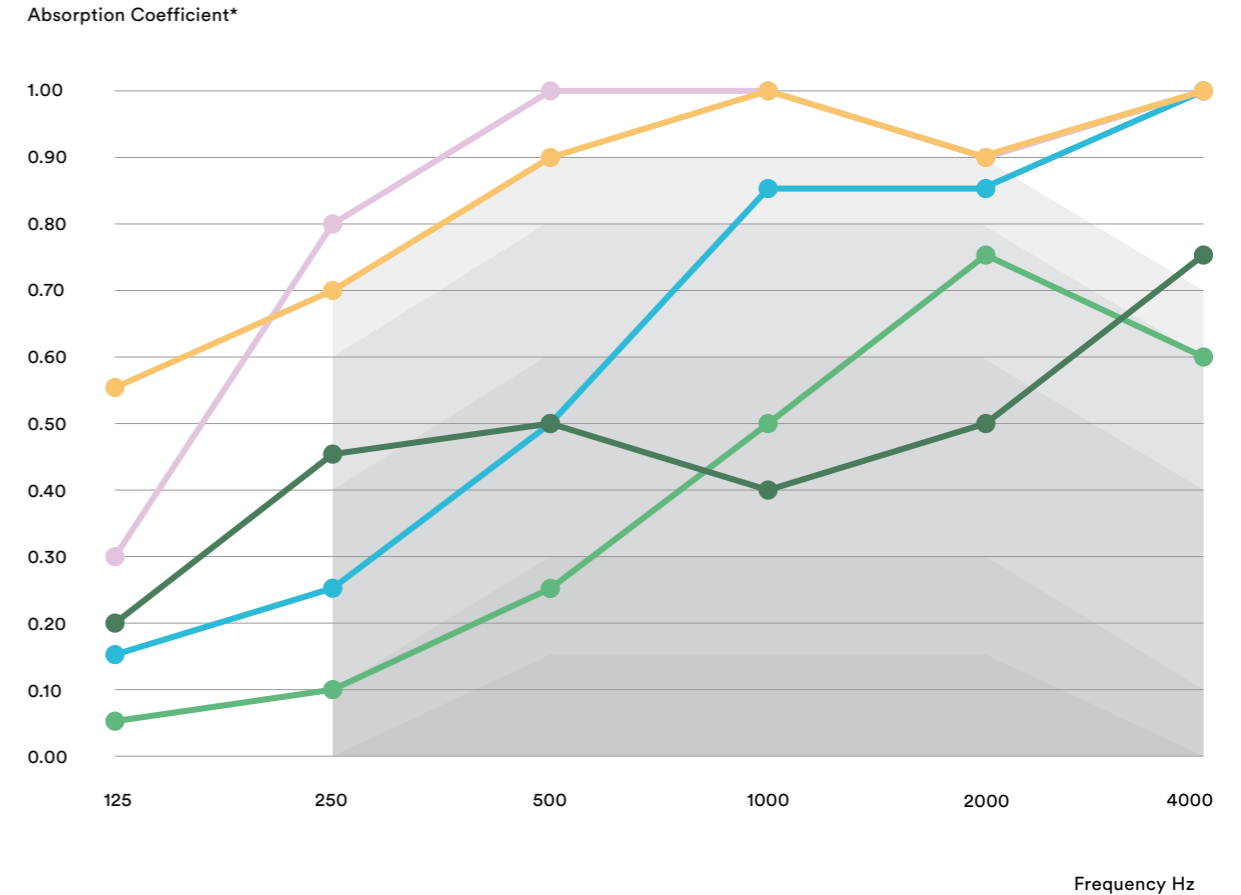

*An absorption coefficient is one of the key efficiency markers for acoustic materials, showing how much sound is absorbed at different frequencies. In the absorption spectrum, 0 indicates perfect reflection, and 1 indicates perfect absorption. Which one is ideal? It really depends on the kind of acoustic landscape you are aiming to build. While some spaces require maximum tranquility, in others, a bit more bustle and ambience may be desired. Our assortment addresses a range of absorption needs to help you achieve your goals.

| Installation | aw | NRC | SAA | Class |
|--|-----------|------|------|-------|
| ● BAUX 25 mm | 0.30 | 0.40 | 0.41 | D |
| ● 3D Pixel | 0.50 (MH) | 0.60 | 0.62 | D |
| ● BAUX 25 mm +40 mm Stone Wool | 1.0 (H) | 0.95 | 0.95 | A |
| ● BAUX 25 mm +200 mm slot | 0.50 (H) | 0.45 | 0.46 | D |
| ● BAUX 25 mm +40 mm Stone Wool + 200 mm slot | 0.90 (H) | 0.90 | 0.90 | A |



Träullit: Part of our history

BAUX Acoustic Wood Wool was created together with Träullit, a traditional family business that was founded in 1946 by Lennart Rääf. Today, Träullit is run by his son Bengt Rääf who continues the legacy of craftsmanship and helps us make boards and panels out of cement-bound wood wool. Sprung from nature, wood wool is a fascinating material made from spruce. When joined together with pure cement, you get a unique hybrid material which provides valuable features to any building. These features include excellent sound absorption, thermal insulation, high thermal storage capacity, resistance to fire, mould and rot, and mechanical strength.



PRODUCT ASSORTMENT

Acoustic Tiles

Large: 580 mm, 22.84"
Small: 290 mm, 11.42"



Large: 580 mm, 22.84"
Small: 290 mm, 11.42"

Square
Large: 2.97 tiles/m², 0.28 tiles/sq.ft.
Small: 11.82 tiles/m², 1.10 tiles/sq.ft.
Thickness: 25 mm, 1.0"

Large: 580 mm, 22.84"
Small: 290 mm, 11.42"



Large: 580 mm, 22.84"
Small: 290 mm, 11.42"

Quarter Circle
Large: 2.97 tiles/m², 0.28 tiles/sq.ft.
Small: 11.82 tiles/m², 1.10 tiles/sq.ft.
Thickness: 25 mm, 1.0"

Large: 580 mm, 22.84"
Small: 290 mm, 11.42"



Large: 580 mm, 22.84"
Small: 290 mm, 11.42"

Circle
Large: 3.78 tiles/m², 0.35 tiles/sq.ft.
Small: 15.14 tiles/m², 1.41 tiles/sq.ft.
Thickness: 25 mm, 1.0"

Large: 580 mm, 22.84"
Small: 290 mm, 11.42"



Large: 1160 mm, 45.7"
Small: 580 mm, 22.84"

Rectangle
Large: 1.49 tiles/m², 0.14 tiles/sq.ft.
Small: 5.95 tiles/m², 0.55 tiles/sq.ft.
Thickness: 25 mm, 1.0"

Large: 290 mm, 11.42"
Small: 145 mm, 5.71"



Large: 1160 mm, 45.7"
Small: 580 mm, 22.84"

Plank
Large: 2.97 tiles/m², 0.28 tiles/sq.ft.
Small: 11.89 tiles/m², 1.10 tiles/sq.ft.
Thickness: 25 mm, 1.0"

Large: 580 mm, 22.84"
Small: 290 mm, 11.42"



Large: 1160 mm, 45.7"
Small: 580 mm, 22.84"

Parallelogram
Large: 2.97 tiles/m², 0.28 tiles/sq.ft.
Small: 11.89 tiles/m², 1.10 tiles/sq.ft.
Thickness: 25 mm, 1.0"

↻ Can be ordered left and right

Large: 580 mm, 22.84"
Small: 290 mm, 11.42"



Large: 580 mm, 22.84"
Small: 290 mm, 11.42"

Triangle
Large: 5.95 tiles/m², 0.55 tiles/sq.ft.
Small: 23.78 tiles/m², 2.21 tiles/sq.ft.
Thickness: 25 mm, 1.0"

Large: 500 mm, 19.68"
Small: 250 mm, 9.84"



Large: 580 mm, 22.84"
Small: 290 mm, 11.42"

Hexagon
Large: 4.45 tiles/m², 0.41 tiles/sq.ft.
Small: 17.82 tiles/m², 1.66 tiles/sq.ft.
Thickness: 25 mm, 1.0"



290 mm, 11.42"
290 mm, 11.42"

3D Pixel
11.89 tiles/m², 1.10 tiles/sq.ft.
Thickness:



Acoustic Panels

580 mm, 22.84"

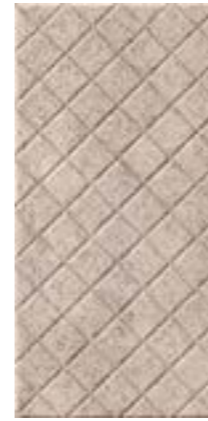

1160 mm, 45.7"

Quilted
1.49 tiles/m², 0.14 tiles/sq.ft.
Thickness: 25 mm, 1.0"

580 mm, 22.84"



1160 mm, 45.7"

Stripes
1.49 tiles/m², 0.14 tiles/sq.ft.
Thickness: 25 mm, 1.0"

580 mm, 22.84"

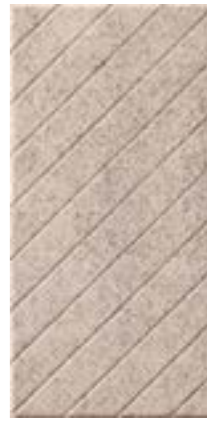

1160 mm, 45.7"

Diagonal
1.49 tiles/m², 0.14 tiles/sq.ft.
Thickness: 25 mm, 1.0"

↻ Can be ordered left and right

580 mm, 22.84"



1160 mm, 45.7"

Check
1.49 tiles/m², 0.14 tiles/sq.ft.
Thickness: 25 mm, 1.0"

580 mm, 22.84"



1160 mm, 45.7"

Lines
1.49 tiles/m², 0.14 tiles/sq.ft.
Thickness: 25 mm, 1.0"

580 mm, 22.84"



1160 mm, 45.7"

Arch
1.49 tiles/m², 0.14 tiles/sq.ft.
Thickness: 25 mm, 1.0"

580 mm, 22.84"



1160 mm, 45.7"

Curve
1.49 tiles/m², 0.14 tiles/sq.ft.
Thickness: 25 mm, 1.0"

↻ Can be ordered left and right

Acoustic Ceilings

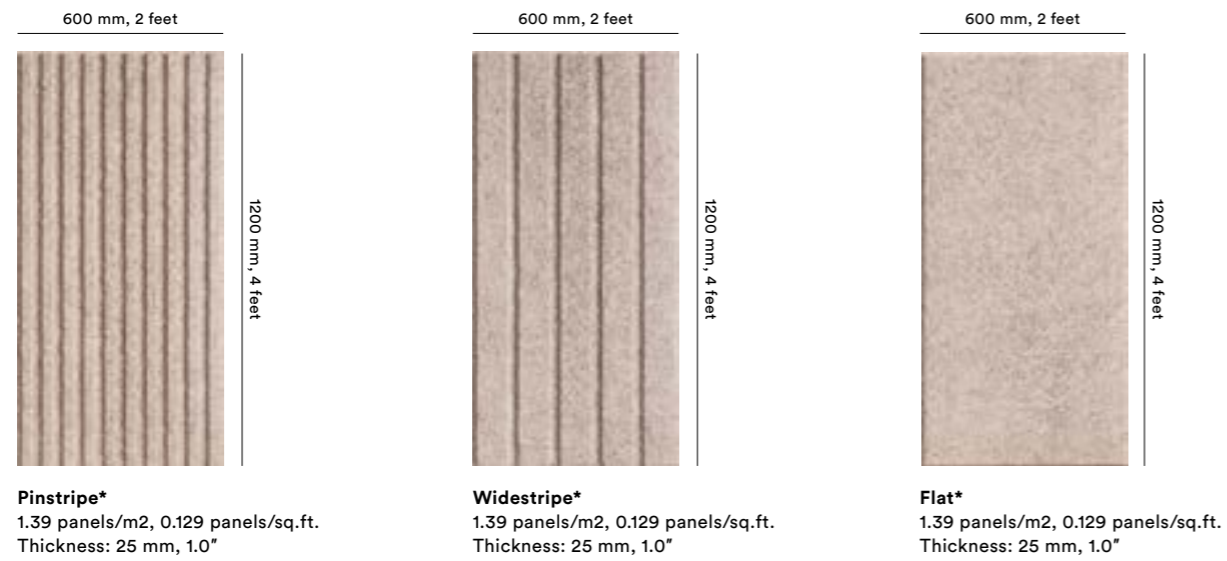

*
Dimensions also available to fit exposed lay-in grids.

Edges

Widestripe and Pinstripe come with a tegular edge
Flat panels come with either tegular edge or beveled (10x10 mm)

Three ways to install

- Directly adhered to ceiling using wooden battens and screws
- Suspended drywall grid with screws (concealed grid)
- Suspended t-grid with lay-in panels (exposed grid)

Acoustic stone wool can be applied behind each option to increase the acoustic performance.



Acoustic Tiles

BAUX Acoustic Wood Wool Tiles are a design-friendly sound solution, available in seven different shapes and more than 20 colours. The versatility of the range makes endless combinations possible, giving architects and designers the opportunity to express their creativity. Combining different shapes allows for geometric, abstract and completely original creations. BAUX Tiles form the centrepiece of the BAUX collection and have become design icons in their own right. Each shape is available in at least two sizes.

ACOUSTIC TILES SQUARE

Large Square

2.97 tiles/m², 0.28 tiles/sq.ft.
Thickness: 25 mm, 1.0"

580 mm, 22.84"

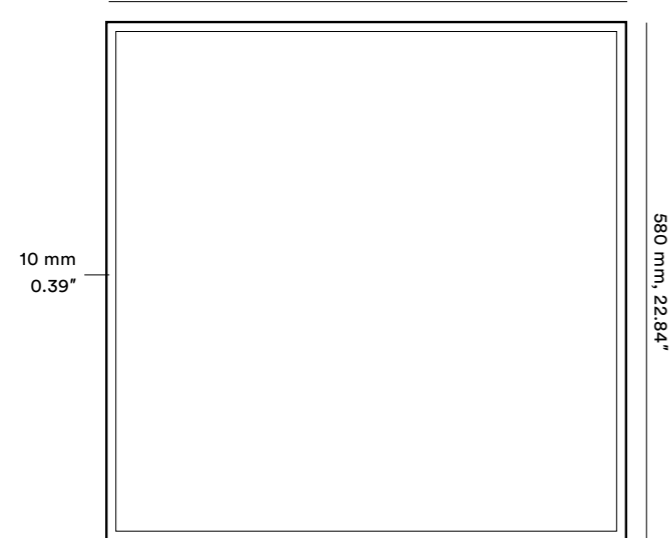

Small Square

11.82 tiles/m², 1.10 tiles/sq.ft.
Thickness: 25 mm, 1.0"

290 mm, 11.42"

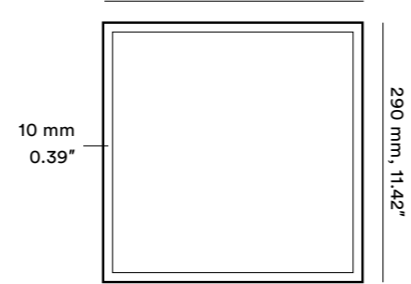

BAUX Square takes on the sharp corners and brings balance and discipline to any space. Available in two sizes. Use it alone or as a steadfast block in a larger design. Lay out a chessboard of contrasting colours. For the diamond look, simply rotate 45°.

ACOUSTIC TILES QUARTER CIRCLE

Large Quarter Circle
2.97 tiles/m², 0.28 tiles/sq.ft.
Thickness: 25 mm, 1.0"

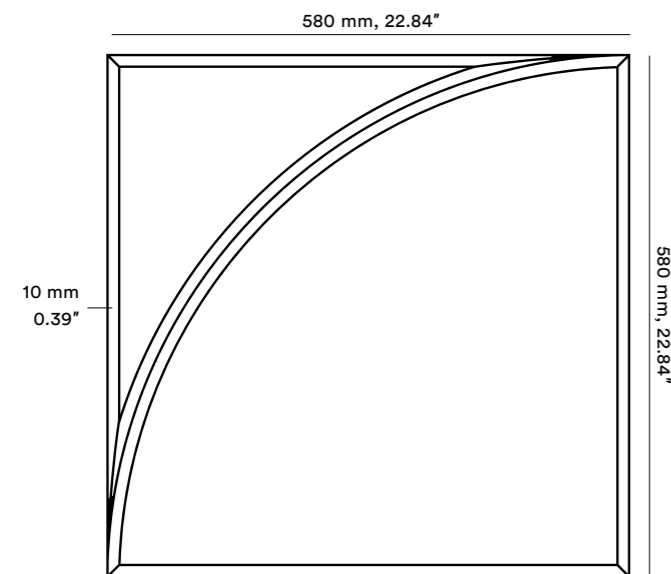

Small Quarter Circle
11.82 tiles/m², 1.10 tiles/sq.ft.
Thickness: 25 mm, 1.0"

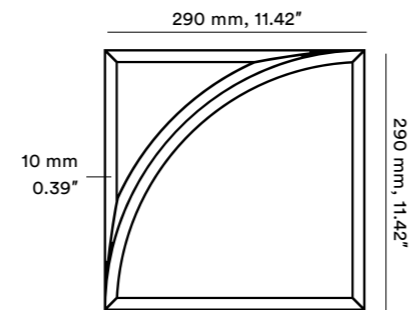

BAUX Quarter Circle sets the room in motion with a kaleidoscope of possibilities. Build the timeless circle one perfect quarter at a time. Or spin the tiles around and mix and match to discover the endless medley of shapes in between. A milled texture adds intrigue. Available in two sizes.

ACOUSTIC TILES CIRCLE

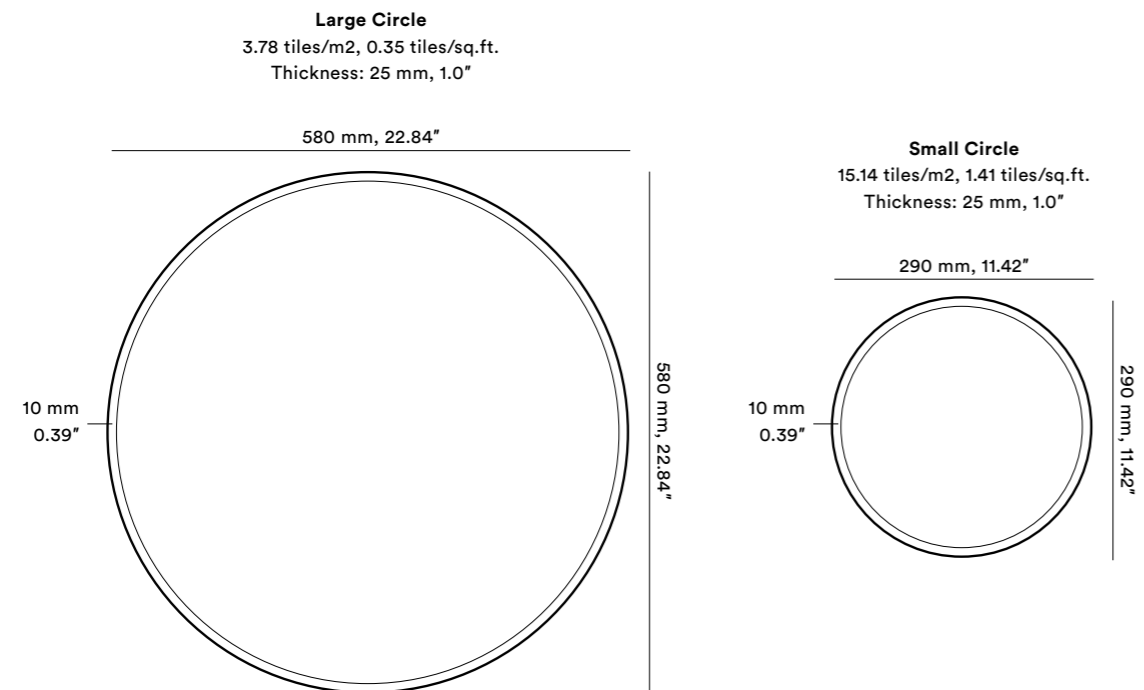

BAUX Circle adds free movement and communal vibes to interior schemes ranging from easygoing to effervescent. Select from two sizes. Complete on its own, it also plays well in a pattern with other circles, animating surfaces for instant impact.

ACOUSTIC TILES HEXAGON

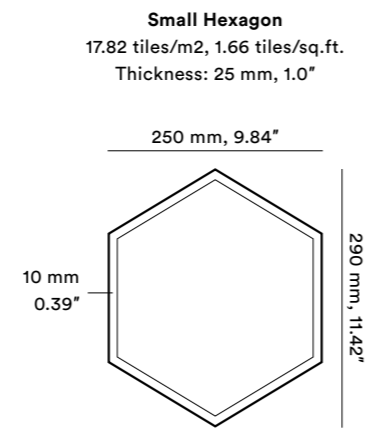
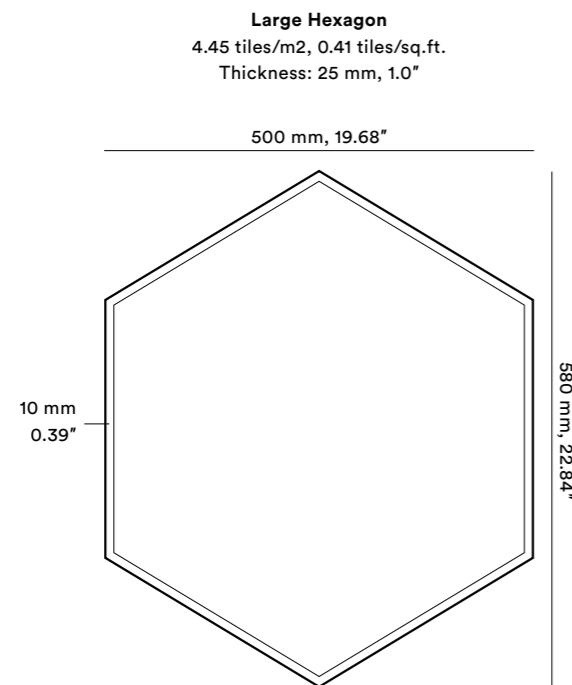

BAUX Hexagon stirs the imagination while imparting a stabilising effect that can bring any room together. Great for intuitive or contemporary designs. Choose from two sizes. Make one your centerpiece. Or link several together with satisfying honeycomb precision.

ACOUSTIC TILES RECTANGLE

Large Rectangle
1.49 tiles/m², 0.14 tiles/sq.ft.
Thickness: 25 mm, 1.0"

580 mm, 22.84"

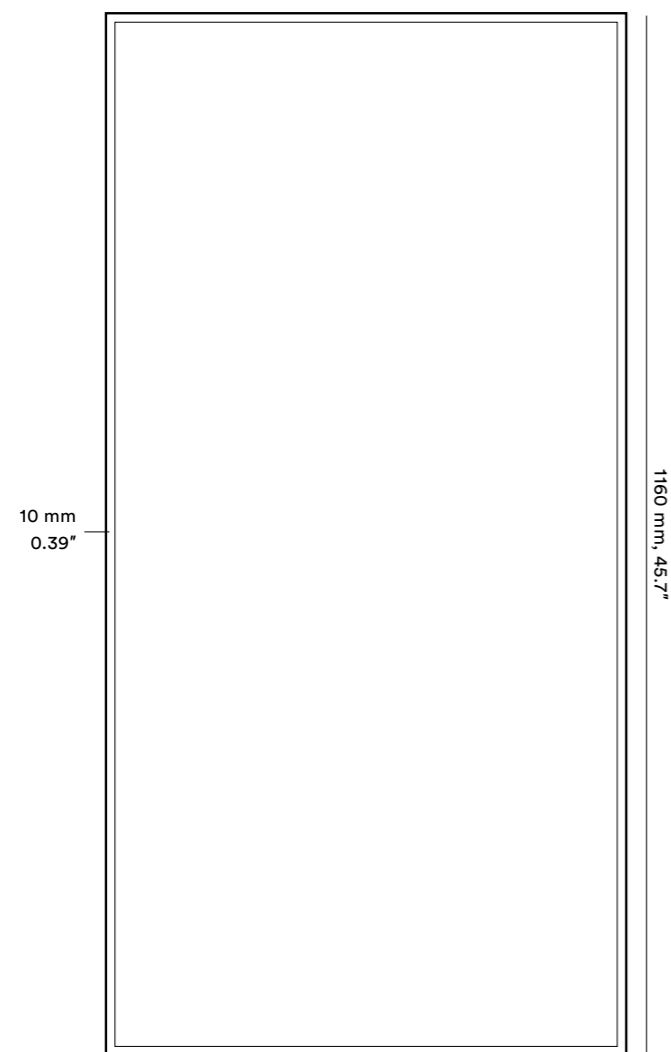

Small Rectangle
5.95 tiles/m², 0.55 tiles/sq.ft.
Thickness: 25 mm, 1.0"

290 mm, 11.42"

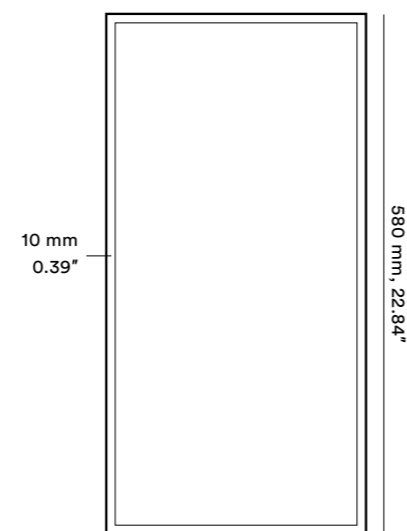

The quintessential building block. With BAUX Rectangle, you can lay down straight lines and patterns with the strength and efficiency of traditional brickwork. Available in two sizes. Build solid walls or write between the lines with compelling pops of colour.

ACOUSTIC TILES PLANK

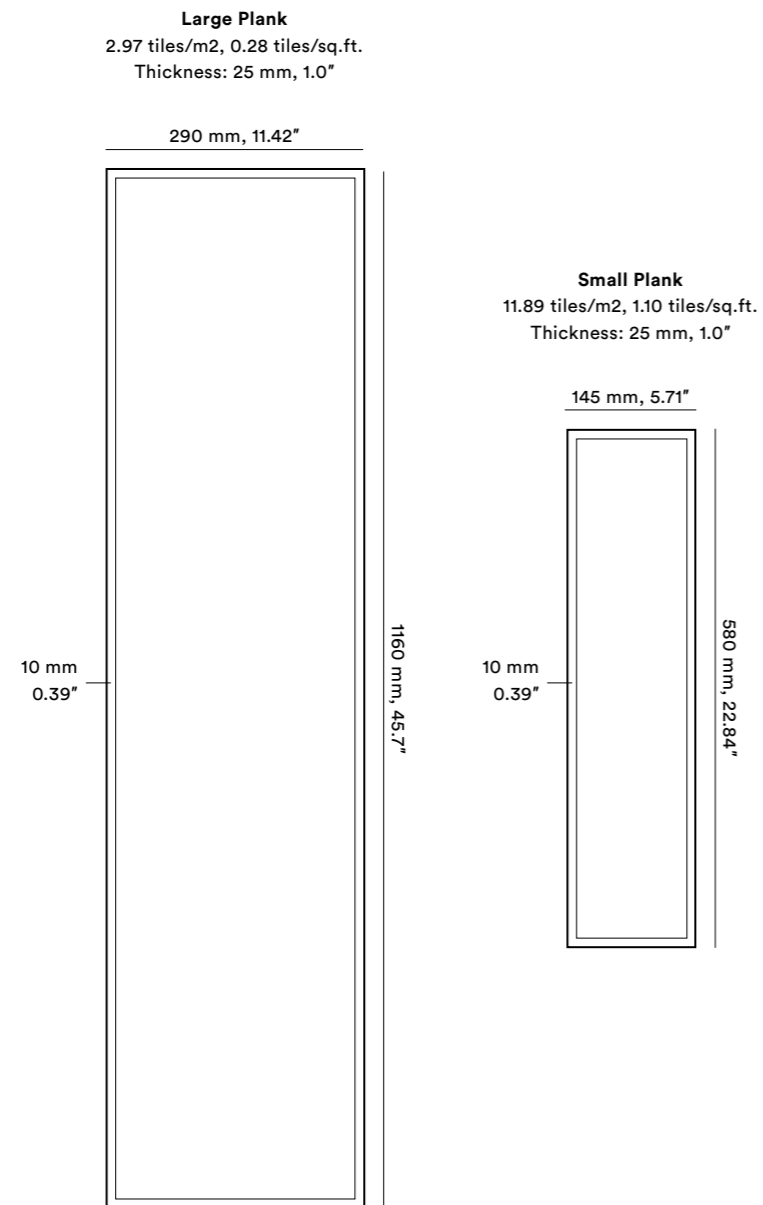

Step into a world of timber, handicraft and carpentry. BAUX Plank lets you create classic patterns influenced by bricklaying, parquet floors and woodwork. Available in two sizes, it highlights the natural wood wool texture for an elegant and minimalist solution.

ACOUSTIC TILES

Parallelogram

Large Parallelogram
2.97 tiles/m², 0.28 tiles/sq.ft.
Thickness: 25 mm, 1.0"

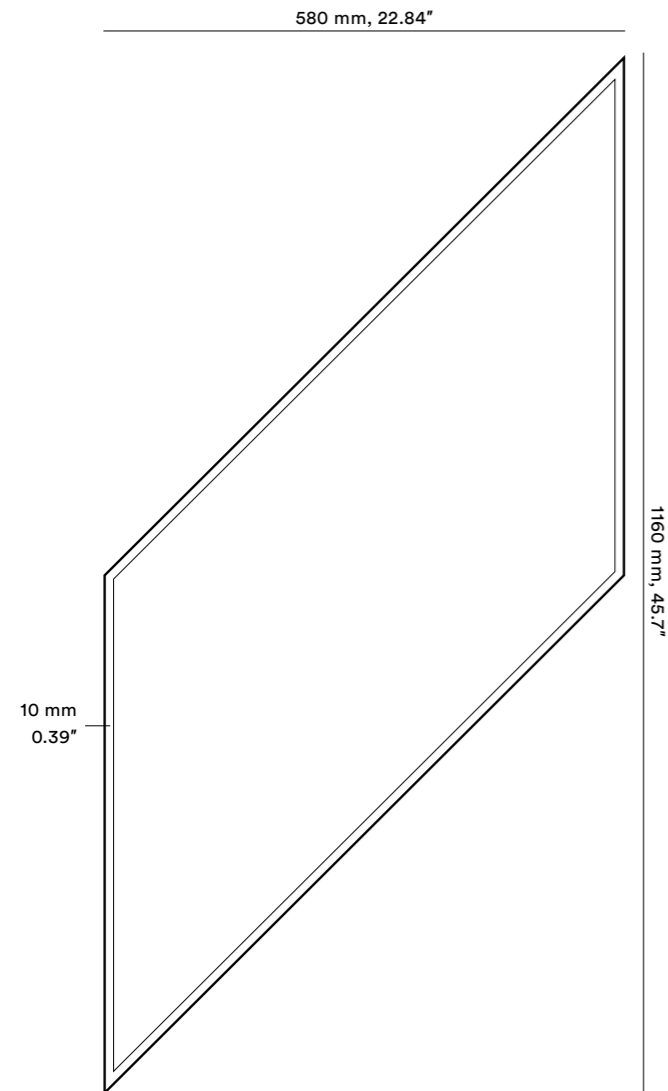

Small Parallelogram
11.89 tiles/m², 1.10 tiles/sq.ft.
Thickness: 25 mm, 1.0"

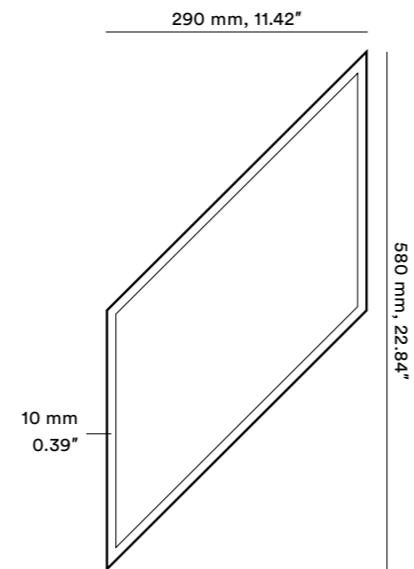

 Can be ordered left and right



From a dynamic realm where all things are equal. BAUX Parallelogram adds movement and intelligence to your interior canvas. Choose from two sizes and a world of patterning possibilities. A timeless shape for colour contrasts and 3D effects.

ACOUSTIC TILES TRIANGLE

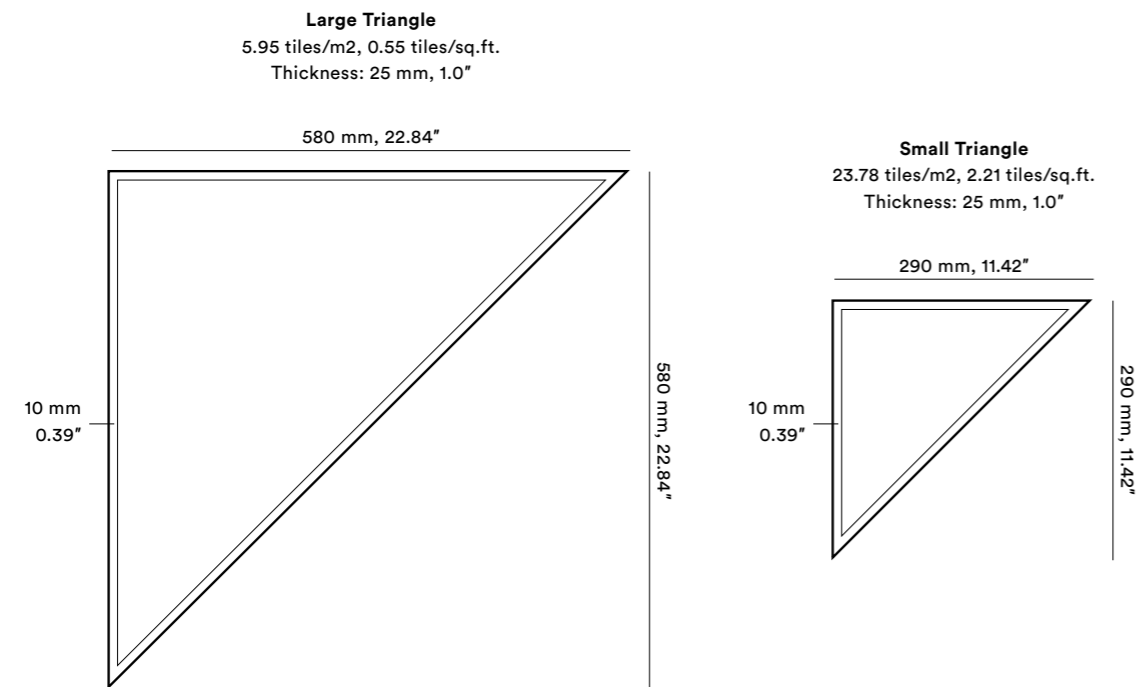

BAUX Triangle emboldens edge designs and gives spaces a strong sense of direction. Available in two sizes, this naturally contrary shape leaves an impact whichever way you place it. Build stability, stir up tension or simply keep the eye moving.

ACOUSTIC 3D PIXELS

3D PIXEL 25

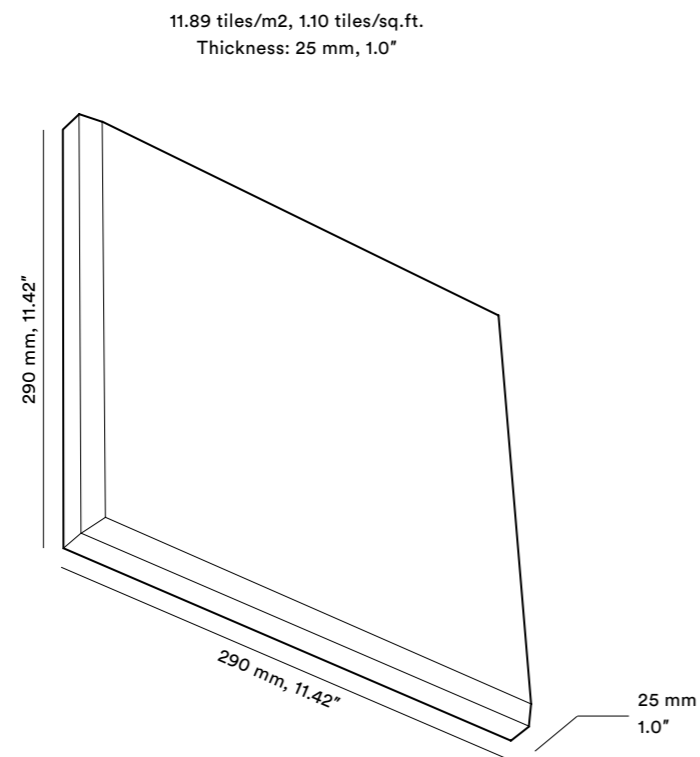

The BAUX 3D Pixel is a playful, creative acoustic tile and our most sound absorbent product. The design makes it possible to work with three dimensions, so it's even easier to create unique, sustainable acoustic designs for any space. The 3D Pixel is inspired by retro 8-bit design and available in three different thicknesses: 25, 50 and 75 mm. Designed as both a visual and acoustic design feature, the Pixel adds a touch of energy and playfulness in projects of any size and scope.

ACOUSTIC 3D PIXELS

3D PIXEL 50

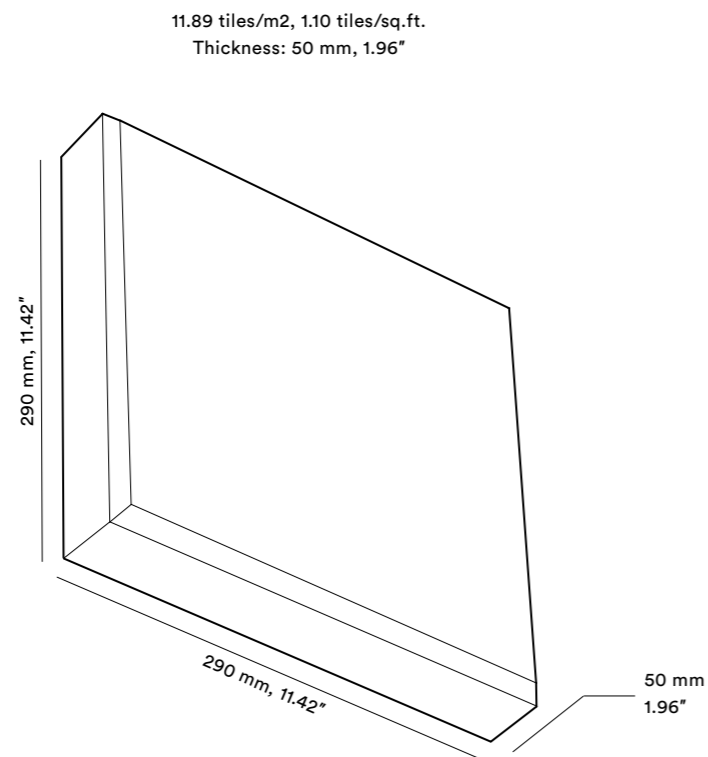

The BAUX 3D Pixel is a playful, creative acoustic tile and our most sound absorbent product. The design makes it possible to work with three dimensions, so it's even easier to create unique, sustainable acoustic designs for any space. The 3D Pixel is inspired by retro 8-bit design and available in three different thicknesses: 25, 50 and 75 mm. Designed as both a visual and acoustic design feature, the Pixel adds a touch of energy and playfulness in projects of any size and scope.

ACOUSTIC 3D PIXELS

3D PIXEL 70

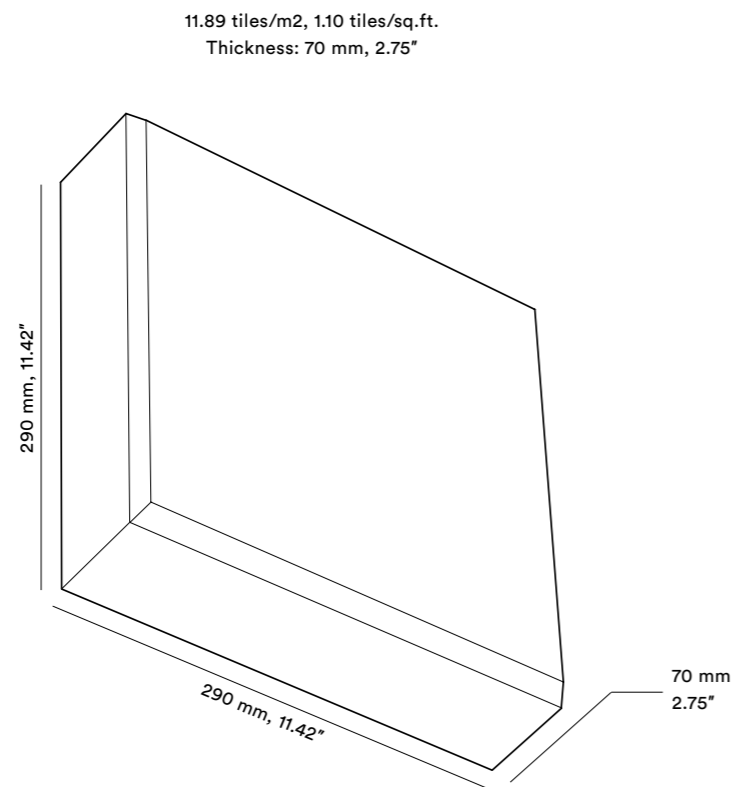

The BAUX 3D Pixel is a playful, creative acoustic tile and our most sound absorbent product. The design makes it possible to work with three dimensions, so it's even easier to create unique, sustainable acoustic designs for any space. The 3D Pixel is inspired by retro 8-bit design and available in three different thicknesses: 25, 50 and 75 mm. Designed as both a visual and acoustic design feature, the Pixel adds a touch of energy and playfulness in projects of any size and scope.



Acoustic Panels

BAUX Acoustic Wood Wool Panels are larger in size and appropriate for both large and small areas. BAUX Acoustic Wood Wool Panels are available in seven patterns: Quilted, Check, Stripes, Lines, Diagonal, Arch and Curve - all designed for endless combinations.

ACOUSTIC PANELS QUILTED

1.49 panels/m², 0.14 panels/sq.ft.
Thickness: 25 mm, 1.0"

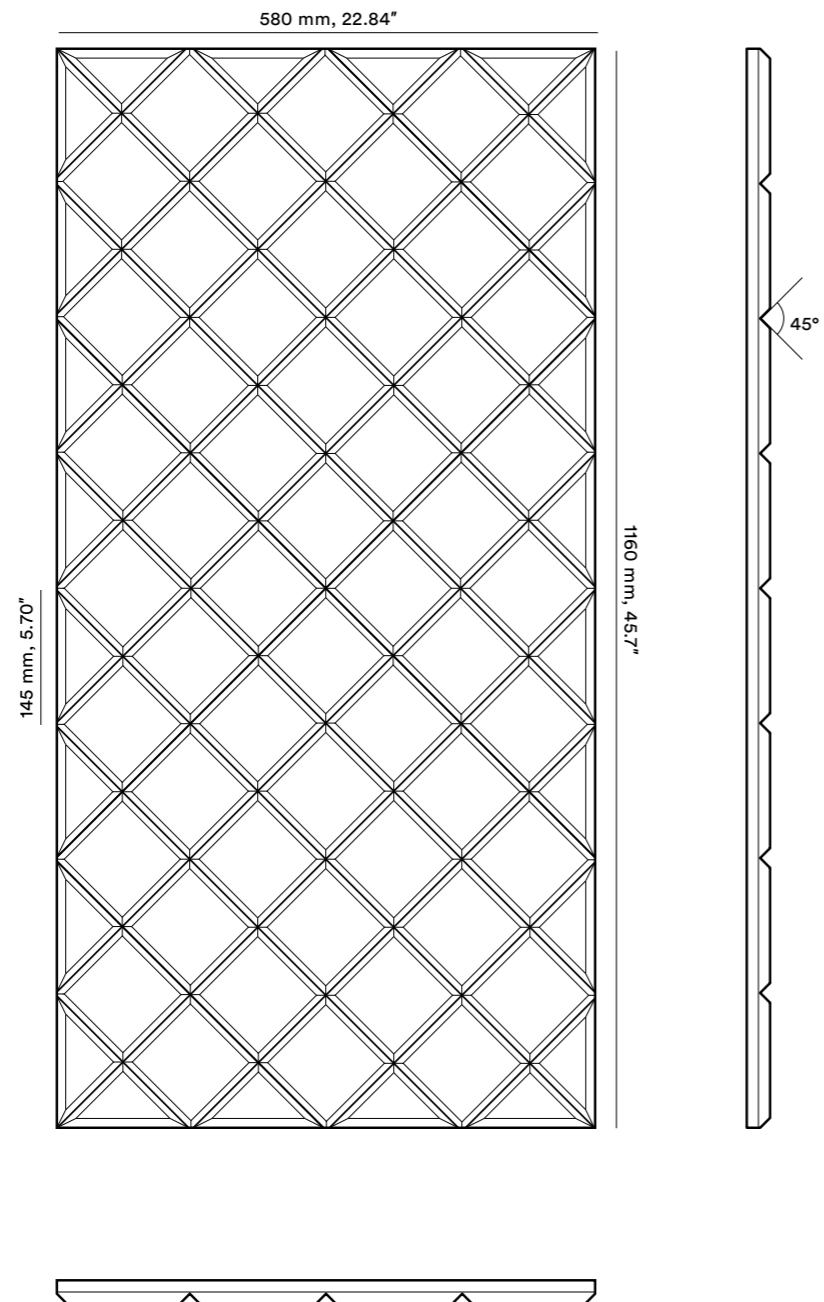

With its intersecting seams and embossed quadrangles, BAUX Quilted is well suited for large communal spaces. Or wherever you want to achieve a multi-layered textile look. Combine with other colours and patterns to create a patchwork of your own design.

ACOUSTIC PANELS STRIPES

1.49 panels/m², 0.14 panels/sq.ft.
Thickness: 25 mm, 1.0"

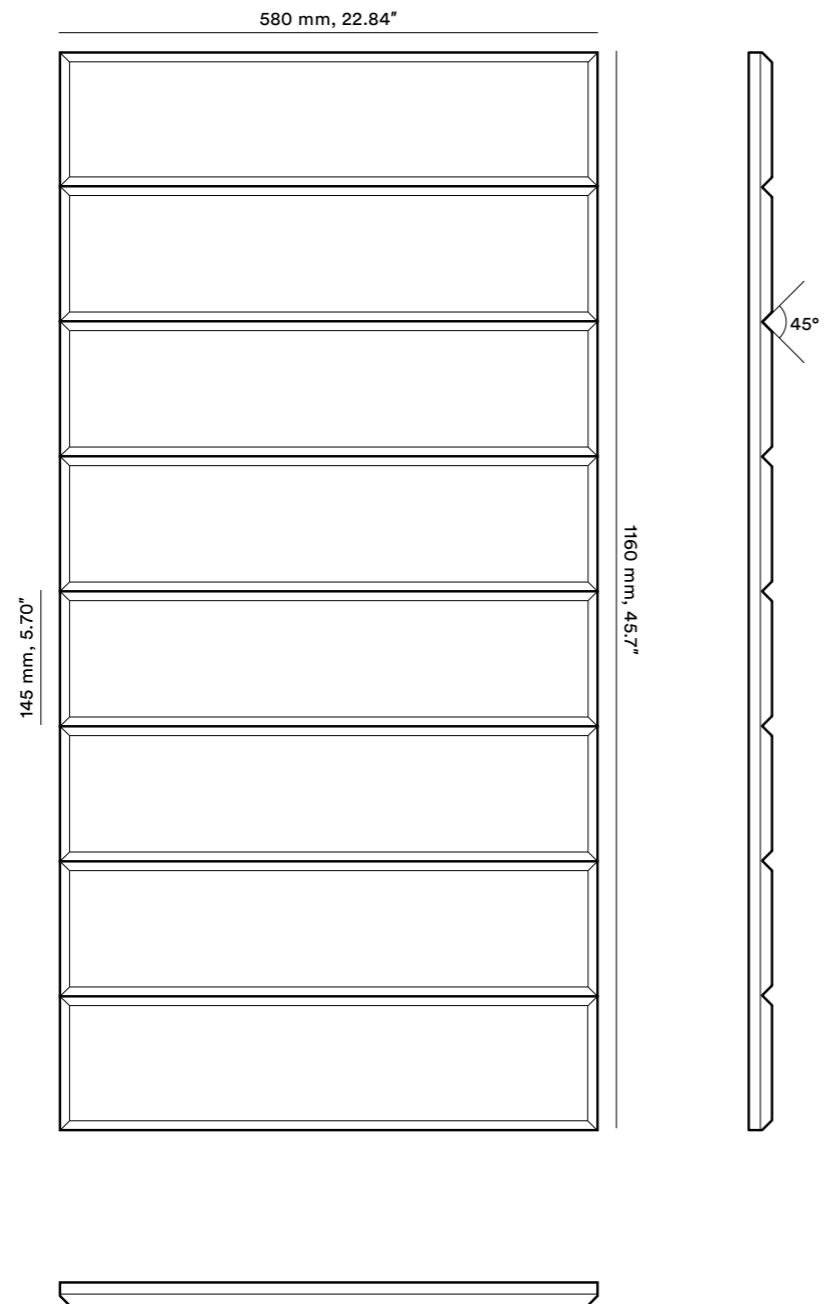

Suitable in both edgy and more classic design schemes, BAUX Stripes generate visual interest and lead the eye wherever you want it to go. Use as a singular accent or build horizontally with multiple panels to explore boundaries and make rooms appear wider.

ACOUSTIC PANELS DIAGONAL

1.49 panels/m², 0.14 panels/sq.ft.
Thickness: 25 mm, 1.0"

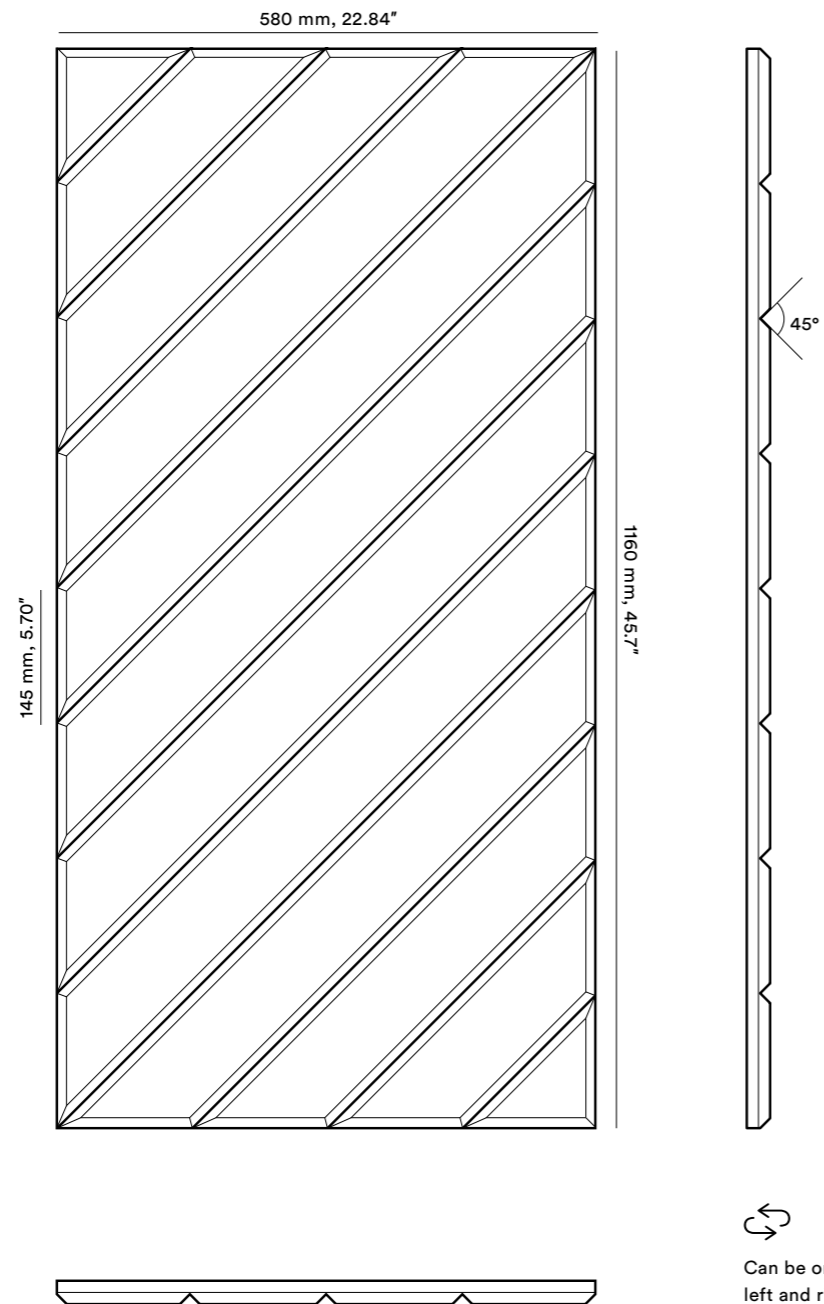

BAUX Diagonal shifts the equilibrium and sets any room into motion. These action-oriented lines send the eye climbing or falling, depending on the direction. A good option for spaces that call for more speed or tension. Pair with alternating diagonals for a zigzag effect.

ACOUSTIC PANELS CHECK

1.49 panels/m², 0.14 panels/sq.ft.
Thickness: 25 mm, 1.0"

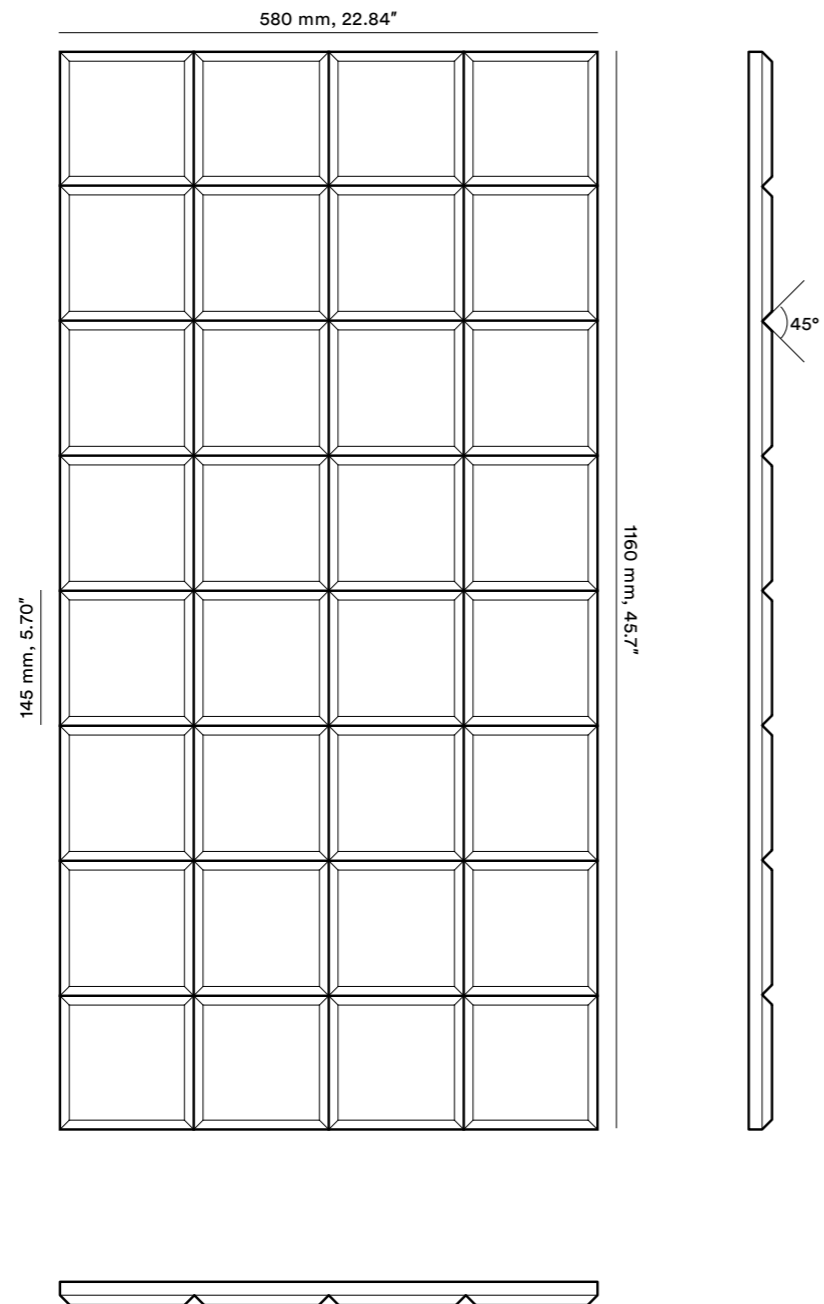

Straight lines and right angles. BAUX Check lets you cover lots of area with a practical repeat of square after square. Ideal for interiors that need a grounding influence. A sober way to deliver colour. Secure a single area or use multiple panels to fortify an entire wall.

ACOUSTIC PANELS LINES

1.49 panels/m², 0.14 panels/sq.ft.
Thickness: 25 mm, 1.0"

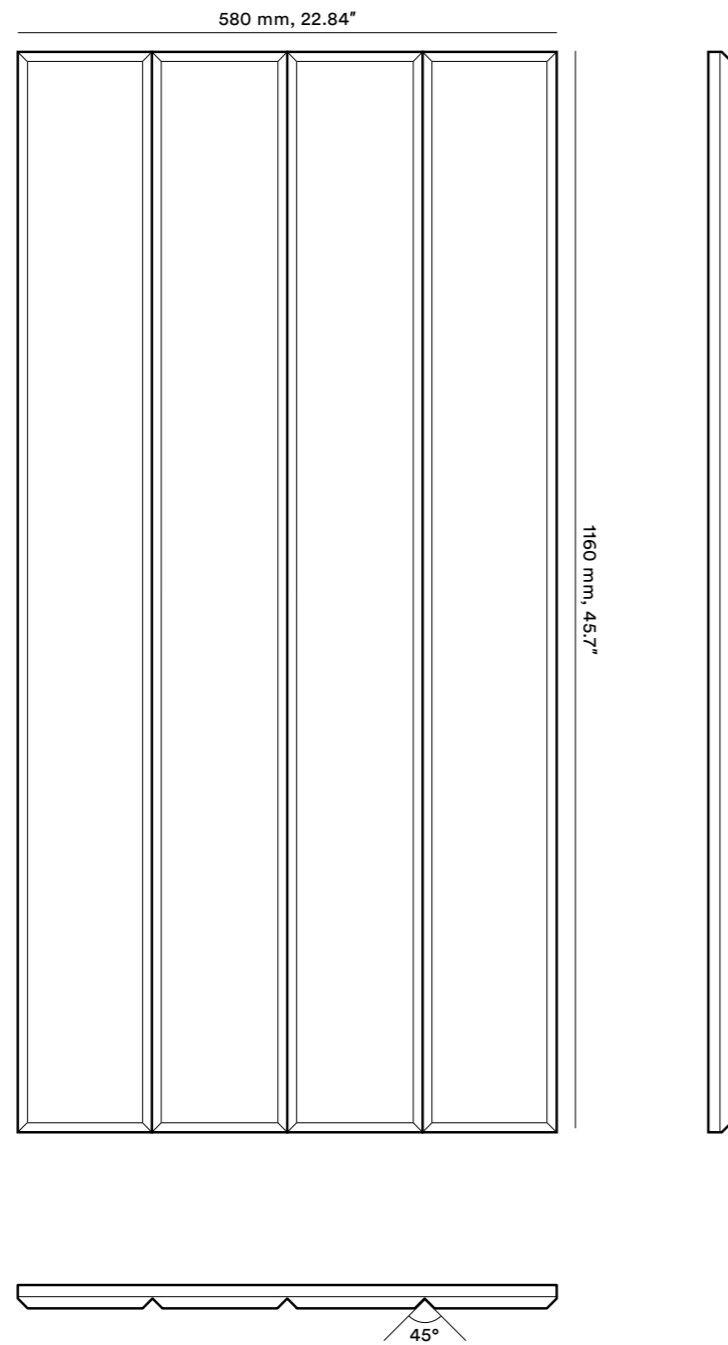

Stretching from the ground up, BAUX Lines naturally push ceilings and accentuate heights while adding pillar-like strength to any space. Use it to create looks ranging from formal to fearless. Build a commanding focal point or an entire wall for monumental impact.

ACOUSTIC PANELS ARCH

1.49 panels/m², 0.14 panels/sq.ft.
Thickness: 25 mm, 1.0"

580 mm, 22.84"

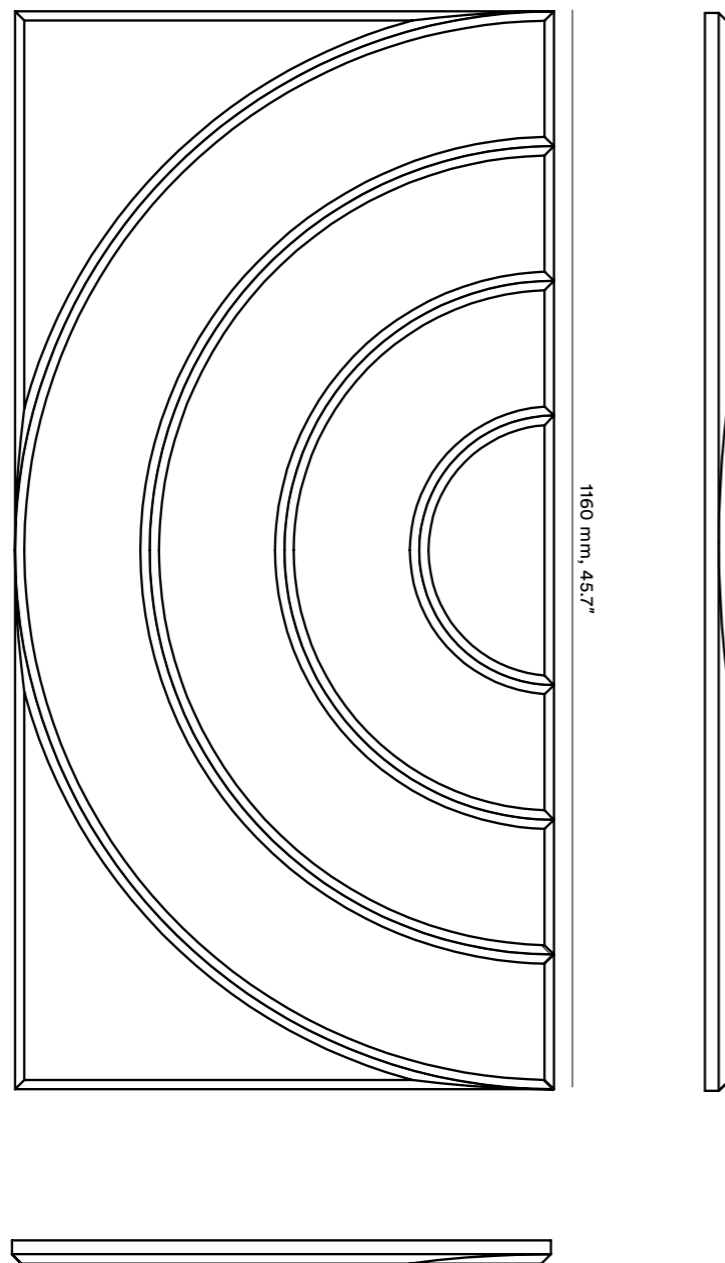

A signal of strength and openness, BAUX Arch makes a memorable architectural moment that can add character to an otherwise modest space. Create singular thresholds, form circular focal points or let multiple Arches move across the wall as a gentle wave.

ACOUSTIC PANELS CURVE

1.49 panels/m², 0.14 panels/sq.ft.
Thickness: 25 mm, 1.0"

580 mm, 22.84"

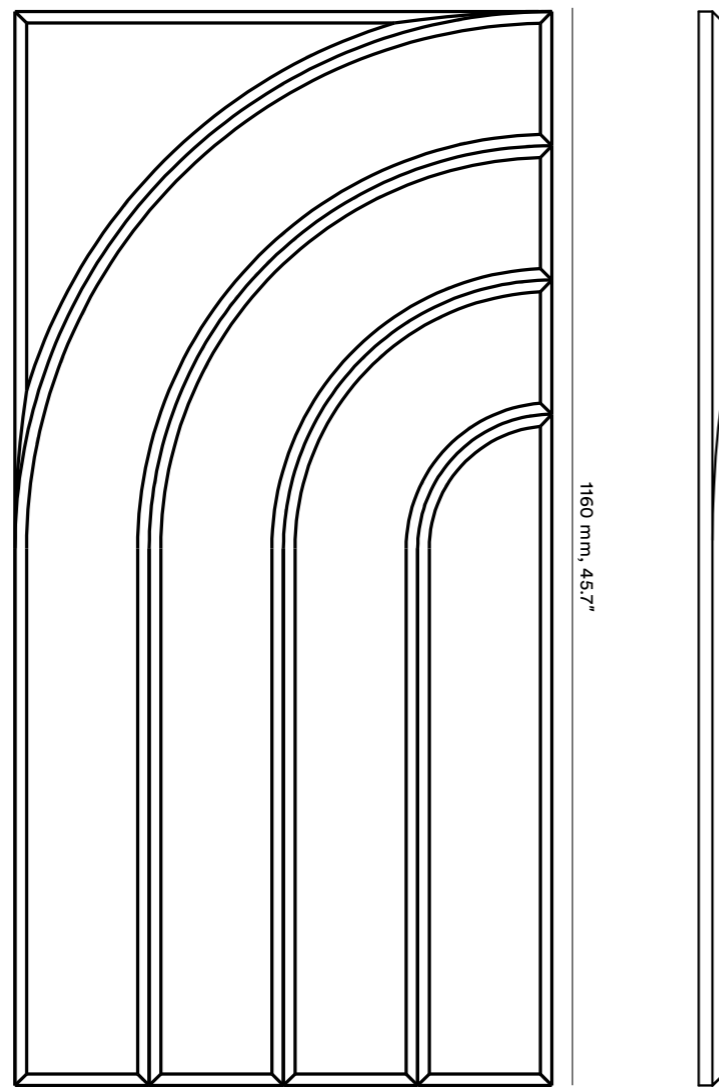

1160 mm, 45.7"



Can be ordered
left and right



BAUX Curve meets corners with soft fluidity and loosens up linear pathways. Great for spaces designed to put people at ease. Use it as a rhythmic interlude between rigid design elements. Or chart a course in a bigger landscape with other BAUX shapes.



Acoustic Ceilings

BAUX Acoustic Wood Wool Ceiling Panels supply coverage in large public areas as well as smaller communal spaces like offices and classrooms. They effectively dampen noise arising from foot traffic and conversations while giving interiors a finished look. Mix and match with three patterns and 21 colours with the option to order customised shades.



The sustainable option for ceilings
Acoustically outstanding
Optimised for installation standards
Easy to cut, crop and adapt
Boundless colour options



ACOUSTIC CEILINGS PINSTRIPE*

1.39 panels/m², 0.129 panels/sq.ft.
Thickness: 25 mm, 1.0"

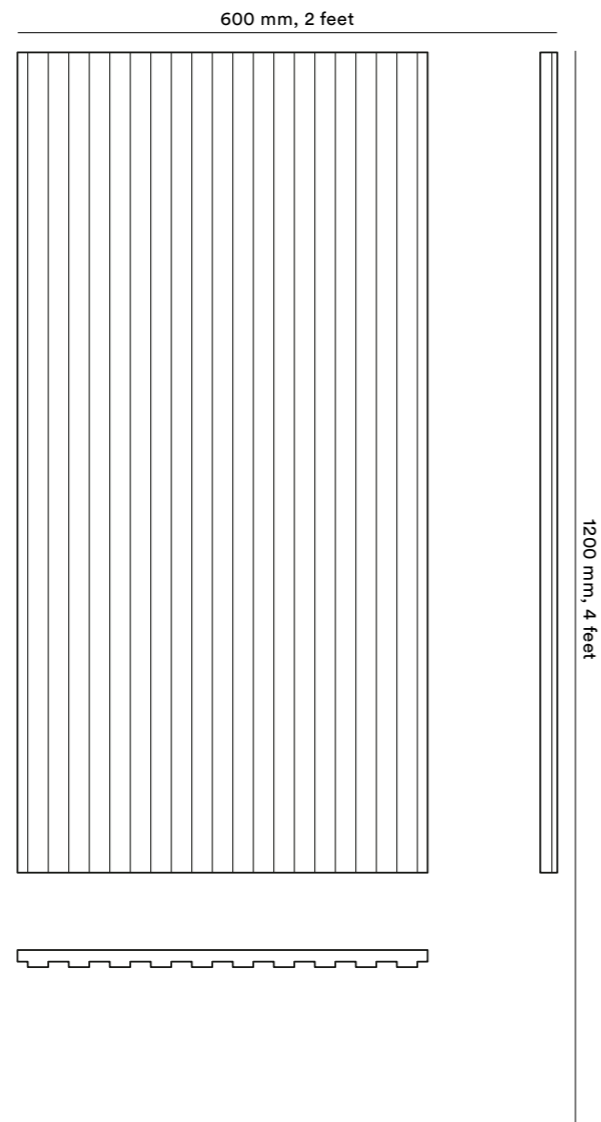

*
Dimensions also available to fit exposed lay-in grids.

Edges
Widestripe and Pinstripe come with a tegular edge
Flat panels come with either tegular edge or beveled
(10x10 mm)

Three ways to install
- Directly adhered to ceiling using wooden battens and screws
- Suspended drywall grid with screws (concealed grid)
- Suspended t-grid with lay-in panels (exposed grid)

Acoustic stone wool can be applied behind each option to
increase the acoustic performance.

The sleek and elegant Pinstripe makes for a confident ceiling. Use it to stretch attention upwards along a slanted plane or to embolden forward movement in hallways. Or mix and match with other BAUX ceiling patterns to create interesting new dimensions.

ACOUSTIC CEILINGS WIDESTRIPE*

1.39 panels/m², 0.129 panels/sq.ft.
Thickness: 25 mm, 1.0"

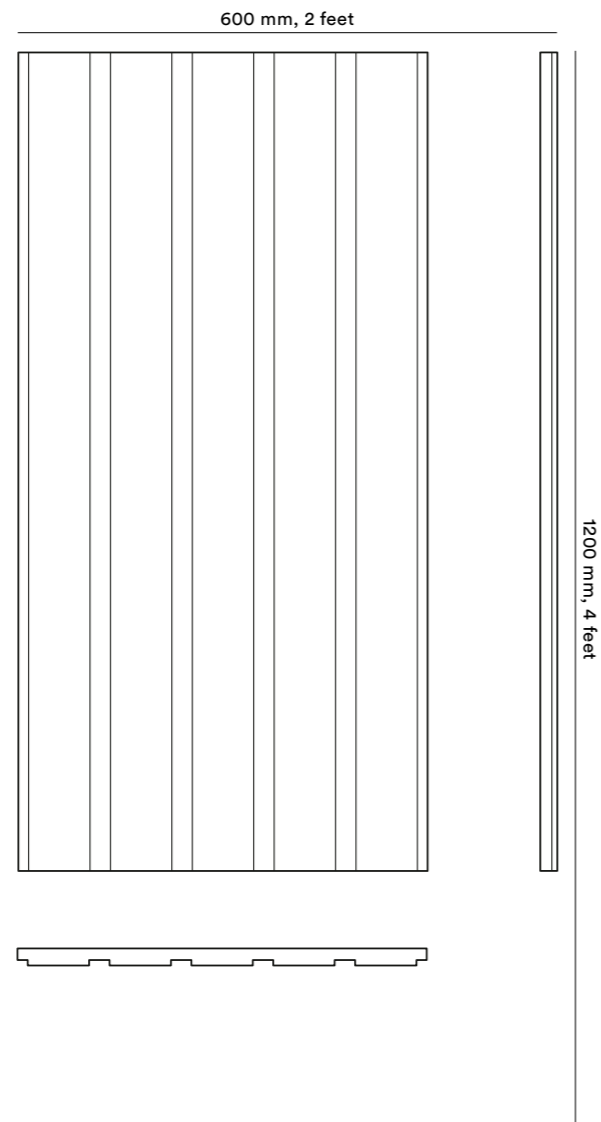

*
Dimensions also available to fit exposed lay-in grids.

Edges
Widestripe and Pinstripe come with a tegular edge
Flat panels come with either tegular edge or beveled
(10x10 mm)

Three ways to install
- Directly adhered to ceiling using wooden battens and screws
- Suspended drywall grid with screws (concealed grid)
- Suspended t-grid with lay-in panels (exposed grid)

Acoustic stone wool can be applied behind each option to
increase the acoustic performance.

The versatile Widestripe plays well in both bold and classic interior schemes. Use it to broaden senses in narrow hallways or to create directional movement along larger planes. Or combine with other BAUX ceiling patterns to build an eye-catching skyscape.

ACOUSTIC CEILINGS FLAT*

1.39 panels/m², 0.129 panels/sq. ft.
Thickness: 25 mm, 1.0"

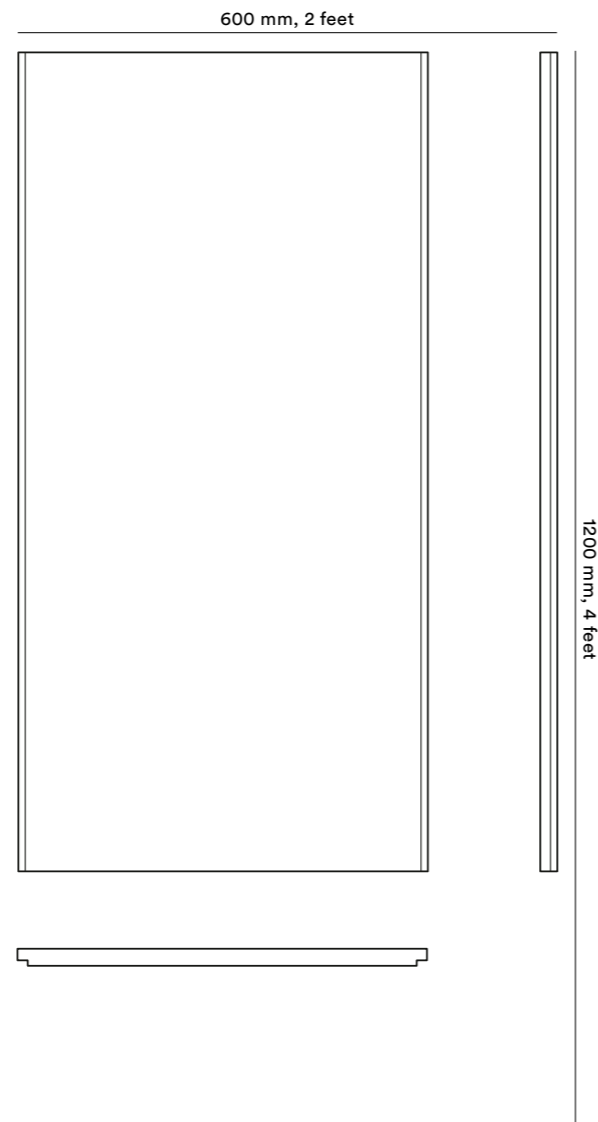

*
Dimensions also available to fit exposed lay-in grids.

Edges
Widestripe and Pinstripe come with a tegular edge
Flat panels come with either tegular edge or beveled
(10x10 mm)

Three ways to install

- Directly adhered to ceiling using wooden battens and screws
- Suspended drywall grid with screws (concealed grid)
- Suspended t-grid with lay-in panels (exposed grid)

Acoustic stone wool can be applied behind each option to increase the acoustic performance.

The effortless Flat pattern gives ceilings a clean slate. Use it to tidy up minimalist interiors or to accentuate softness in more restful spaces. Or frame it with other BAUX ceiling patterns to create sky-high focal points and multi-dimensional interest.

COLOUR COLLECTION

Woods



Sky in the sea

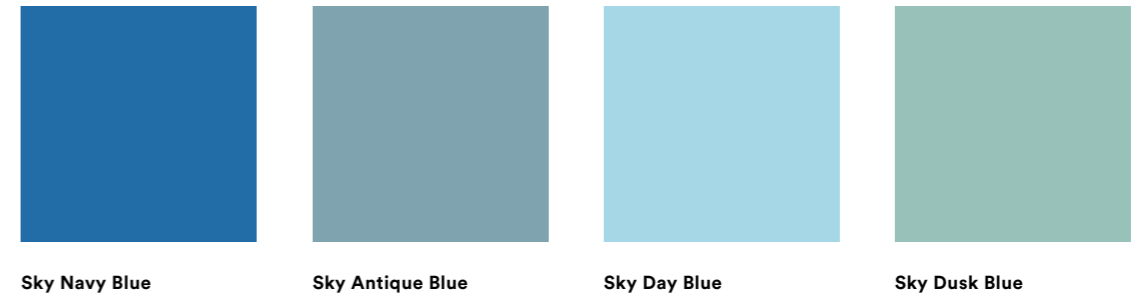

Heat of the sun

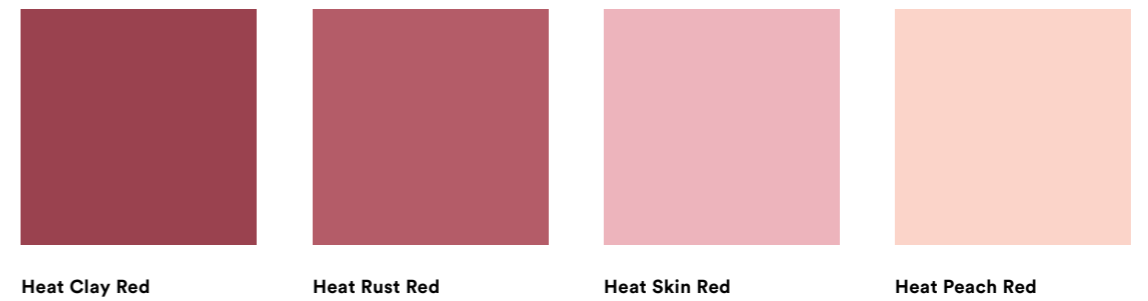

Earth and mountain

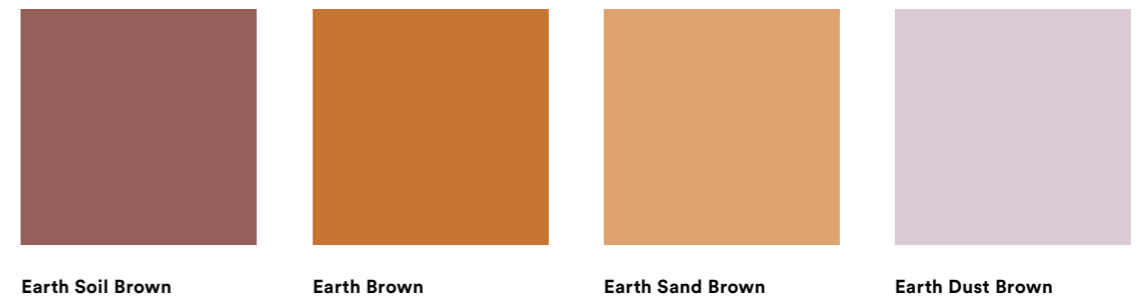

Clouds

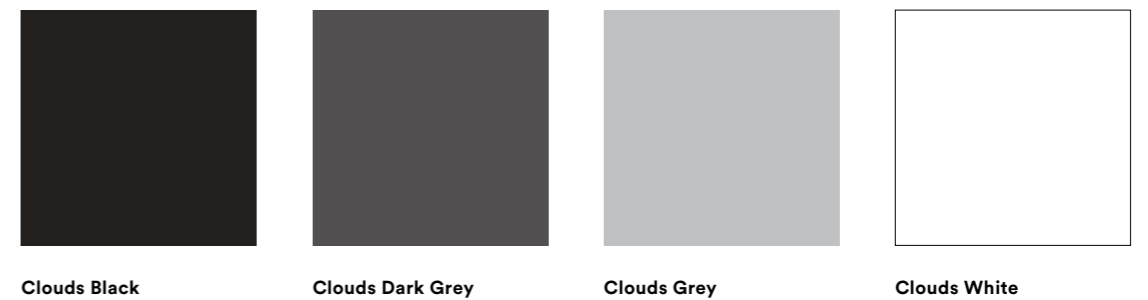

Natural colour available. You can also order BAUX Wood Wool unpainted.



Custom colours available upon request.



Woods



Woods Pine Green



Woods Moss Green



Woods Bright Green

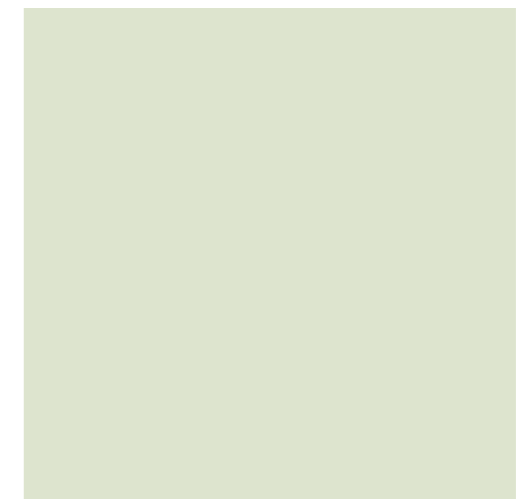

Woods Pale Green

Bring the ritual of forest bathing indoors with this lush and dewy palette of greens. Even exposure to simulated green settings like interiors has been shown to help people let go of stress and feel a bit happier.



Sky in the sea



Sky Navy Blue



Sky Antique Blue

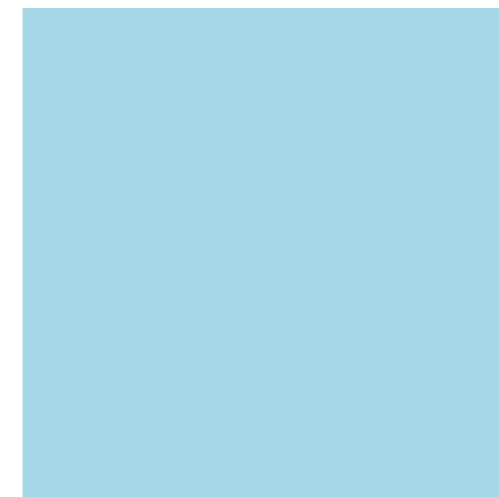

Sky Day Blue



Sky Dusk Blue

Here's a soothing spectrum of blues that captures the hypnotic interplay of light and matter that only happens when the sky and sea meet. An ideal choice for interiors that call for peace and collective order.



Heat of the sun



Heat Clay Red



Heat Rust Red



Heat Skin Red



Heat Peach Red

Stir up excitement and anticipation. Just like the sun, this lively palette of reds offers varying degrees of warmth from sunrise to sunset. An empowering boost for spaces where strength and action is needed.



Earth and mountain



Earth Soil Brown



Earth Brown



Earth Sand Brown



Earth Dust Brown

Lay a solid foundation with colours as stable and comforting as the ground we walk on and the rocks we climb. These toasty browns and oranges serve as versatile and intimate neutrals in interior design schemes.



Clouds



Clouds Black



Clouds Dark Grey

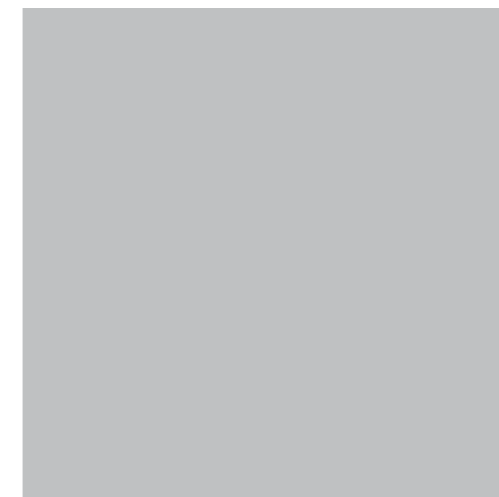

Clouds Grey

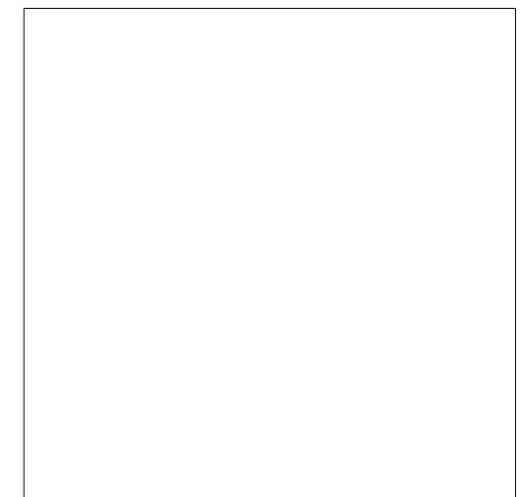

Clouds White

Like the clouds above, this contrasting collection floats along the grey scale exposing darkness and light. Lighter hues give interiors an expansive and airy feel, while darker ones add impact and sophistication.

ACOUSTICS

Acoustics are both an aesthetic and functional element of design that should be integrated into the design process as early as possible.

Acoustical benefit: Absorption

BAUX Acoustic Wood Wool is an excellent sound absorber. The wood fibres capture noise, transforming the sound waves into micro-movement and heat. The result is a more restful acoustic environment.

Before treatment:

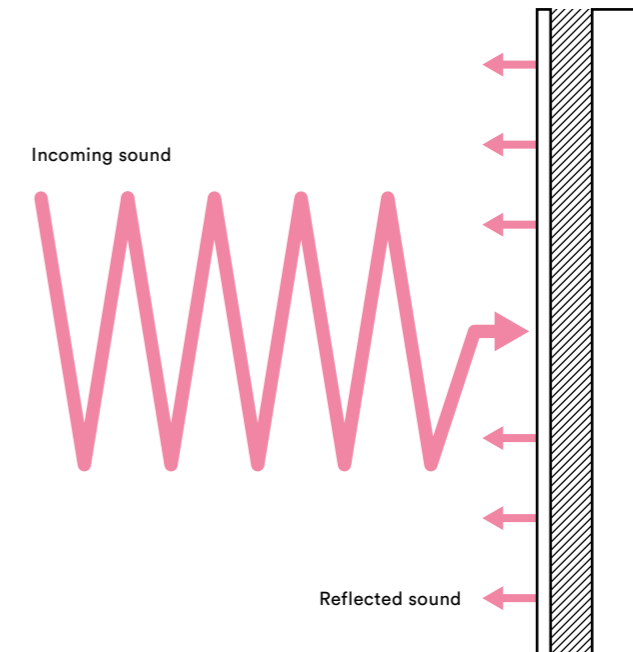

After treatment:

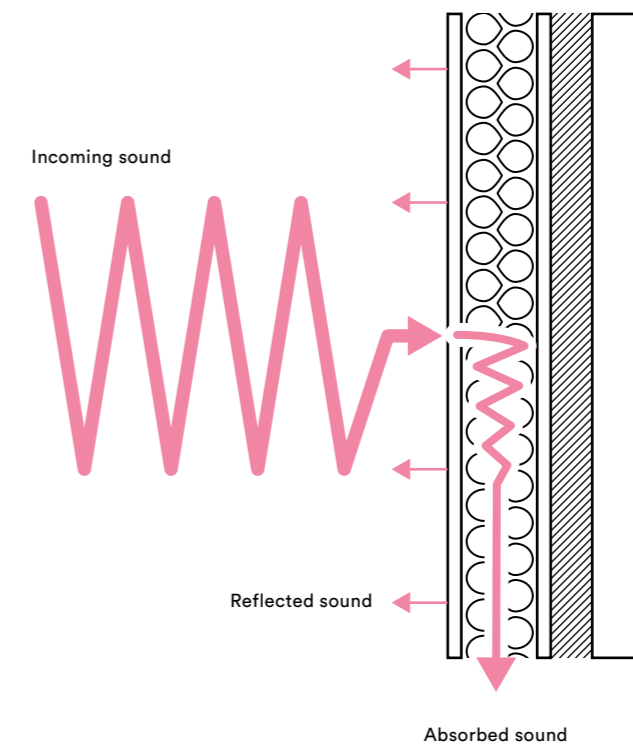

Acoustical benefit: Diffusion

BAUX Acoustic Wood Wool also diffuses sound.
It's irregular surface breaks up reflections and spreads them out in different directions. This minimises distractions and helps maintain acoustical continuity.

Before treatment:

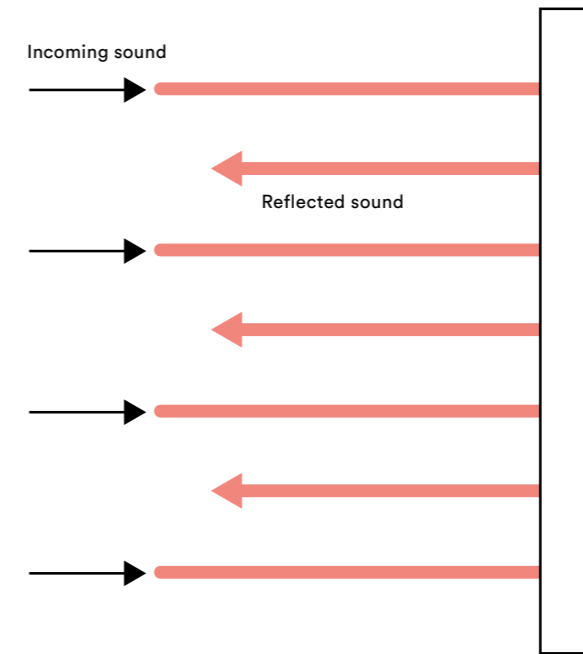

After treatment:

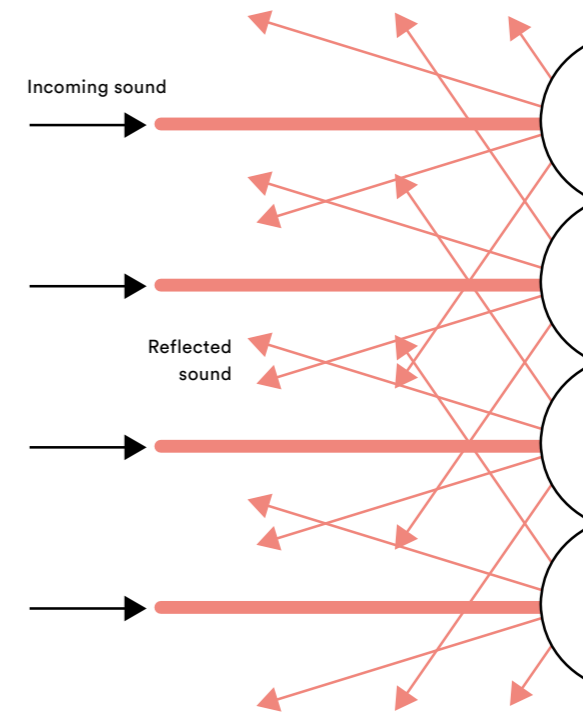

This graph shows the practical absorption coefficient of BAUX Acoustic Wood Wool at any given frequency.

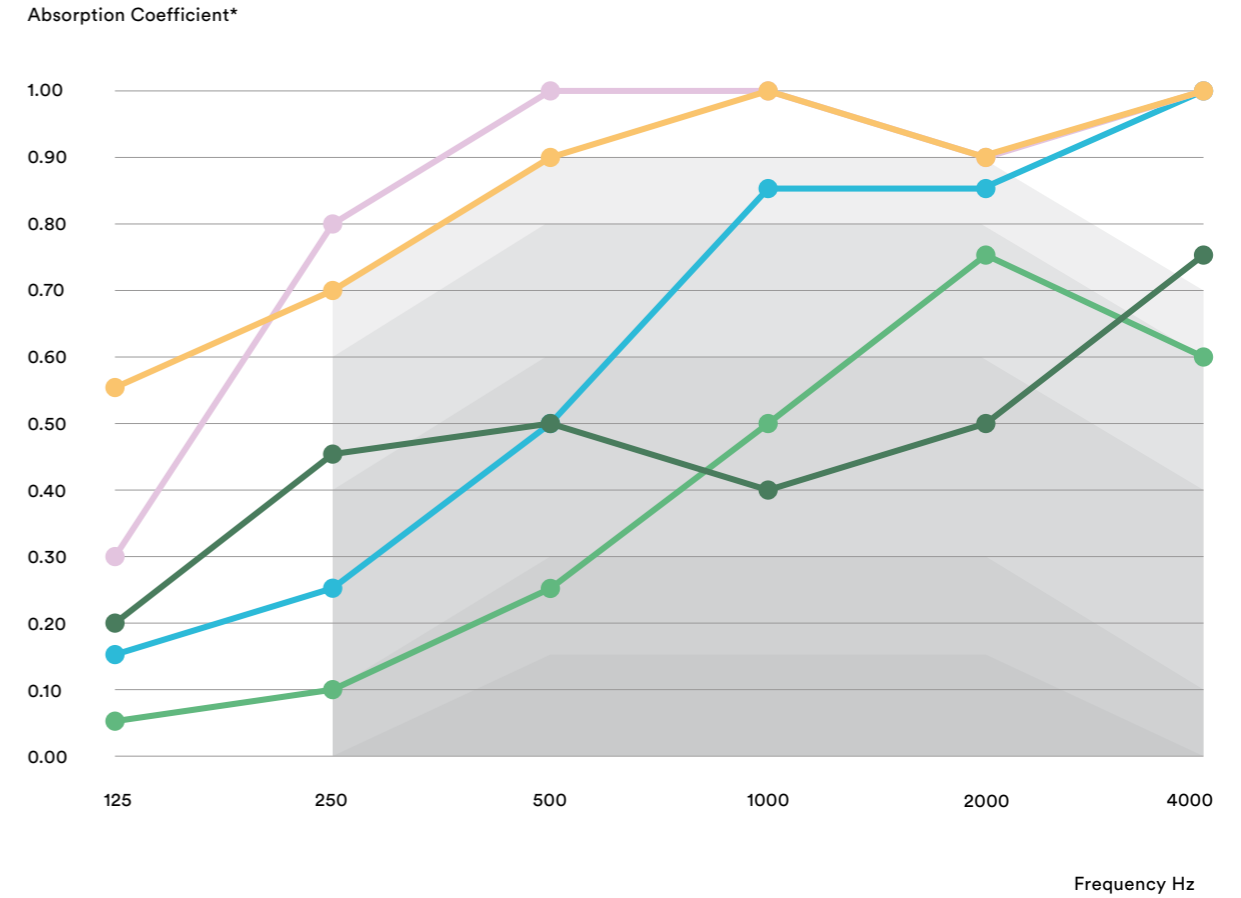

*An absorption coefficient is one of the key efficiency markers for acoustic materials, showing how much sound is absorbed at different frequencies. In the absorption spectrum, 0 indicates perfect reflection, and 1 indicates perfect absorption. Which one is ideal? It really depends on the kind of acoustic landscape you are aiming to build. While some spaces require maximum tranquility, in others, a bit more bustle and ambience may be desired. Our assortment addresses a range of absorption needs to help you achieve your goals.

| Installation | aw | NRC | SAA | Class |
|---|-----------|------|------|-------|
| ● BAUX 25 mm | 0.30 | 0.40 | 0.41 | D |
| ● 3D Pixel | 0.50 (MH) | 0.60 | 0.62 | D |
| ● BAUX 25 mm + 40 mm Stone Wool | 1.0 (H) | 0.95 | 0.95 | A |
| ● BAUX 25 mm + 200 mm slot | 0.50 (H) | 0.45 | 0.46 | D |
| ● BAUX 25 mm + 40 mm Stone Wool + 200 mm slot | 0.90 (H) | 0.90 | 0.90 | A |

BENEFITS OF BAUX ACOUSTIC WOOD WOOL

1.

Contributes to greater wellbeing and productivity in public spaces by dampening excess sound and reflections for more restful acoustics.

2.

Made from natural and recyclable materials with functional properties for high performance and durability in all kinds of climates.

3.

Design-friendly, with a versatile range of shapes and colours that allow for endless combinations and total creative freedom.

4.

Approved for safety indoors, with high fire and moisture resistance, zero harmful chemicals or additives and extremely low emissions.

5.

Features superb thermal insulation abilities, contributing to a smaller energy footprint and more comfortable indoor climate.

BOTTOM LINE

BAUX Acoustic Wood Wool has all the ingredients for excellent acoustic design—performance, sustainability and a full palette of shapes and colours to play with.

CREATE YOUR DESIGN



BAUX IS FOUNDED ON THE BELIEF THAT BUILDING MATERIALS SHOULD BE BOTH SURPRISINGLY FUNCTIONAL AND REMARKABLY BEAUTIFUL.

BAUX IS FOUNDED ON THE BELIEF THAT BUILDING MATERIALS SHOULD BE BOTH SURPRISINGLY FUNCTIONAL AND REMARKABLY BEAUTIFUL.

www.baux.se/patterns
BAUX





BAUX Patterns

BAUX Patterns makes it simpler than ever to transform any space with a unique BAUX design. Browse through pattern collections and choose from over 500 designs. All free to download.

Each Pattern is designed to repeat like wallpaper so you can quickly calculate how many tiles you need for your wall or space. All patterns include 3D architectural files.

Visit the pattern library at baux.com

BAUX Digital Toolkit

BAUX Digital Toolkit is a free resource packed with downloadable files that help working professionals design, sketch and construct sustainable, beautiful and acoustically pleasing environments for spaces of every size.

Download the full toolkit or specific files at baux.com



3D/CAD

For many professionals, computer-aided design is an indispensable tool when it comes to visualising designs for upcoming projects. All of our Acoustic Wood Wool product files are available in formats compatible with AutoCAD, Sketchup, ArchiCAD, Rhino and more.

[.3ds](#) [.dwg](#) [.dxf](#) [.igs](#) [.skp](#)
[.sldprt](#) [.step](#)



BIM/Revit

Building information modelling is an essential tool used by professionals for virtual construction during the project planning process. All of our Acoustic Wood Wool product files are available in compatible formats, including detailed elements featuring BAUX colour schemes.

[.rfa](#)



Keynote and Powerpoint

If you need help getting the ideation process rolling, our ready-to-go presentation is an excellent catalyst. Available in both Keynote and Powerpoint formats, it features "drag & drop" objects so you can start designing right away. Great for workshops and client meetings.

[.key](#) [.pptx](#)

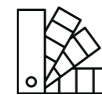

BAUX Patterns

BAUX Patterns makes it easier than ever to transform any space with a unique Acoustic Wood Wool design. Select from over 500 pre-measured 3D patterns, each designed to repeat like wallpaper so you can quickly calculate exactly how many tiles you'll need for your project.

[.png](#) [.tiff](#) [.jpg](#) [.dwg](#) [.txt](#)



Adobe Illustrator

An easy and efficient design tool, a lot of professionals choose Adobe Illustrator to help bring their creative visions to life. All of our Acoustic Wood Wool product files are ready to go in compatible formats for easy upload so you can start playing with shapes, colours and patterns.

[.ai](#)



Adobe Photoshop

A popular tool for editing photos and graphics. Adobe Photoshop can help you perfect your presentation and exhibit your design at its fullest potential. To make things easier, we supply high-resolution pictures of all Acoustic Wood Wool products in vectorised PDF format.

[.psd](#)



Texture Files

The next best thing to experiencing it in person. Texture files give you an idea of what a material will bring to a space in terms of colour and feel. All of our Acoustic Wood Wool product files are available in texture file formats. Great for renderings or as colour samples.

[.ai](#)



Mounting DWG

When it's time to build, we have the information you'll need to translate your designs from drawings to real life. We provide mounting files in DWG format, which can be attached to drawings, as well as installation instructions for the entire BAUX Acoustic Wood Wool range.

[.dwg](#)

INSPIRATION



Triangle
 Square
 Woods Pale Green
 Woods Pine Green



Triangle
 Parallelogram
 Square
 Rectangle
 Heat Clay Red
 Earth Soil Brown
 Earth Brown
 Earth Sand Brown



3D Pixel
 Triangle
 Parallelogram
 Earth Brown
 Earth Sand Brown
 Heat Peach Red
 Woods Pine Green
 Sky Day Blue
 Clouds White
 Natural



Triangle
 Parallelogram
 Earth Brown
 Sky Navy Blue



3D Pixel Clouds Grey Earth Dust Brown Heat Skin Red



Triangle Square Rectangle Clouds Black Clouds Dark Grey Clouds White Sky Day Blue Woods Pine Green







3D Pixel Clouds Dark Grey



Triangle Rectangle Parallelogram Square Sky Day Blue Sky Antique Blue Sky Navy Blue Woods Pale Green Sky Dusk Blue Clouds Black Heat Skin Red Heat Rust Red Heat Clay Red Heat Peach Red









 Triangle

 Sky Day Blue
  Sky Antique Blue
  Sky Navy Blue



 Circle

 Earth Dust Brown
  Heat Skin Red
  Earth Brown

 Woods Pale Green
  Sky Day Blue
  Sky Dusk Blue



 Triangle
  Rectangle

 Sky Day Blue
  Sky Antique Blue
  Sky Navy Blue

 Parallelogram
  Square

 Sky Dusk Blue
  Earth Dust Brown
  Woods Pine Green

 Earth Sand Brown
  Earth Soil Brown
  Clouds Dark Grey

 Heat Skin Red
  Heat Rust Red
  Heat Clay Red

 Heat Peach Red



 Hexagon

 Natural
  Clouds Grey
  Sky Dusk Blue



Plank

Natural



Lines

Earth Brown Earth Soil Brown
Earth Dust Brown Earth Sand Brown



Plank

Natural



Lines Quilted Diagonal

Sky Day Blue Clouds White

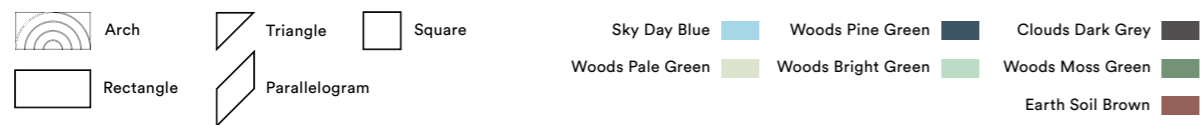
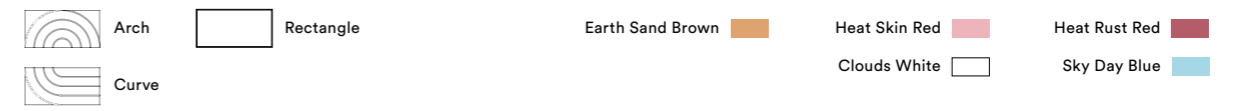
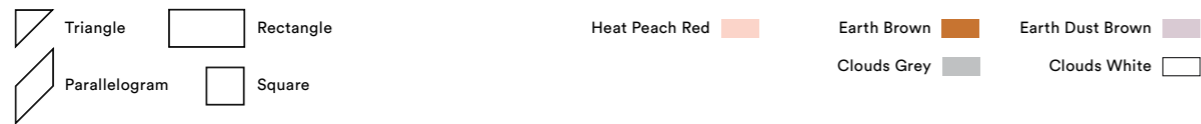

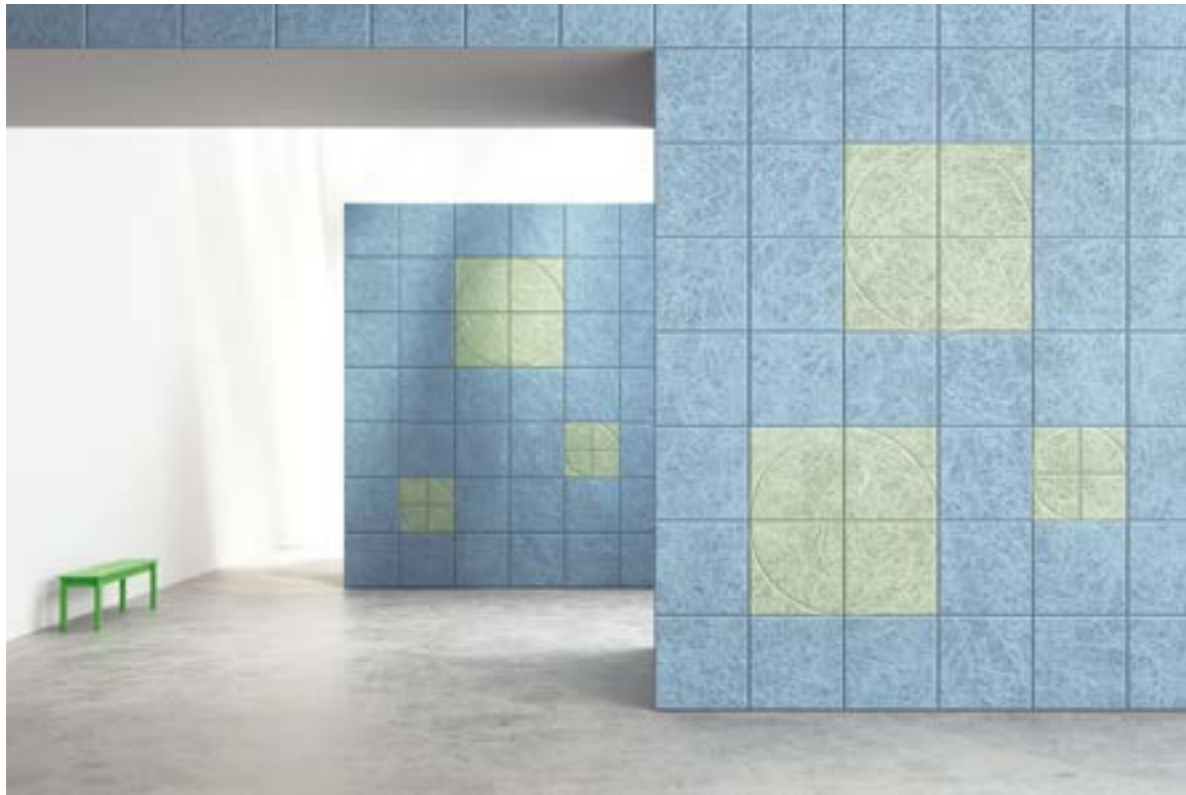

Quarter Circle Square Woods Pale Green Sky Antique Blue



Quarter Circle Woods Bright Green Sky Day Blue





Quarter Circle Heat Peach Red Earth Brown





Quarter Circle Square Rectangle (small) Clouds Grey Sky Navy Blue



 Widestripe

 Sky Day Blue
  Sky Antique Blue
  Sky Navy Blue

 Clouds Grey
  Sky Dusk Blue



 Widestripe

 Woods Moss Green
  Woods Pine Green

 Woods Bright Green
  Woods Pale Green



 Pinstripe

 Earth Brown
  Earth Soil Brown

 Earth Dust Brown
  Earth Sand Brown



 Widestripe
  Pinstripe

 Heat Rust Red
  Heat Clay Red

 Heat Skin Red
  Heat Peach Red

SPECIFICATIONS

BAUX

Acoustic Wood Wool

| Material: | Ingredient: | Share (%): | Function: | Origin: | Supplier: | Certificates/other: |
|-----------|------------------------------------|------------|--------------------------------|----------------------|------------|-----------------------|
| | Portland cement CAS: 65997-15-1 | 44% | Binder | SE & DK (20%/80%) | Cementa | |
| | Wood swedish fir | 37% | Sound absorber. Visual look | Sweden (SE) | Own forest | FSC & PEFC |
| | Water | 10% | Binder | Sweden (SE) | | |
| | Limestone powder CAS: 471-34-1 | 9% | Binder | Sweden (SE) | Nordkalk | |
| | Paint, water based | <1% | Visual look | Finland (FI) | Teknos | Group M1, The Swan |

About: BAUX Acoustic Wood Wool is a functional, natural material made from two of the world's oldest building materials, wood and cement. The combination is simple and ingenious. Wood fiber offers excellent insulation, heat retention and sound absorption. BAUX is made from certified wood – FSC® and PEFC™ – guaranteeing that it can be traced back to responsible forestry operations. Cement, a proven and popular building material, is the binder that provides strength, moisture resistance and fire protection. Therefore, BAUX acoustic products are versatile and durable in all climates.

| Physical appearance & performance: | Appearance: | Interior/Exterior wall or ceiling panels. | Steam coefficient permeability: | 4-5x10-6m2/s |
|------------------------------------|-----------------------|---|---------------------------------|--|
| | Colours: | Unpainted or painted | Air permeability: | ~20 m3/m2hPa |
| | Odour: | None | Light reflection: | Unpainted 43%, White painted 69% (lower for darker colours) |
| | Solubility in water: | None | | |
| | Density: | ~300kg/m3 (11kg/m2 = 2.25 lbs/ft2 t25mm) | Tensile strength: | 0,007 MPa |
| | Dust: | No measurable particle attraction | Compression strength: | 0,4 MPa |
| | Emissions: | <1µg/m2 x h | Flexural strength: | 0,7 MPa |
| | Asbestos release: | No content | Deformation: | 4 mm (0.05 MPa pressure), 5mm (0.10 MPa pressure) |
| | Recycled content: | None | TVOC emission rate (µg/m2h): | 14/33 (unpainted/painted)* |
| | Harmful additives: | None | VVOC emission rate (µg/m2h): | 97* |
| | Red list chemicals: | None | SVOC emission rate (µg/m2h): | <2* |
| | Product lifetime: | 50 years | Formaldehyde (µg/m2h): | <1* |
| | Thermal resistance: | RD m2-K/W = 0,294 (25 mm) 0,588 (50 mm) and 0,823 (70 mm) | | |
| | Thermal conductivity: | Average 0,085 W/m°C (25 mm thickness) | | |

(1) RNK & Sitac blasted 10 year old tiles with air jet (2) Swedish Institute of Technical Research - Protocol 90K10102
*measured after 28 days, report RISE Research Institutes of Sweden AB

| | | |
|------------------------------|---------------------------|--|
| Fire & standards: | Classification: | A-classed according to ASTM E84 standard (Flame spread Index = 0 Smoke developed Index = 0). B-s1, d0 according to EN 13823 EN ISO 11925-2 |
| | Extinguishing media: | Water, carbon dioxide, foam or dry chemicals |
| | Harmonized standard: | SS-EN 13168:2012+A1:2015 - Thermal insulation products for buildings, factory made wood wool products SS-EN 13964:2014 - Suspended Ceilings |
| | Stability and reactivity: | Stability: Stable; Conditions to avoid: None known |

Acoustical characteristics:

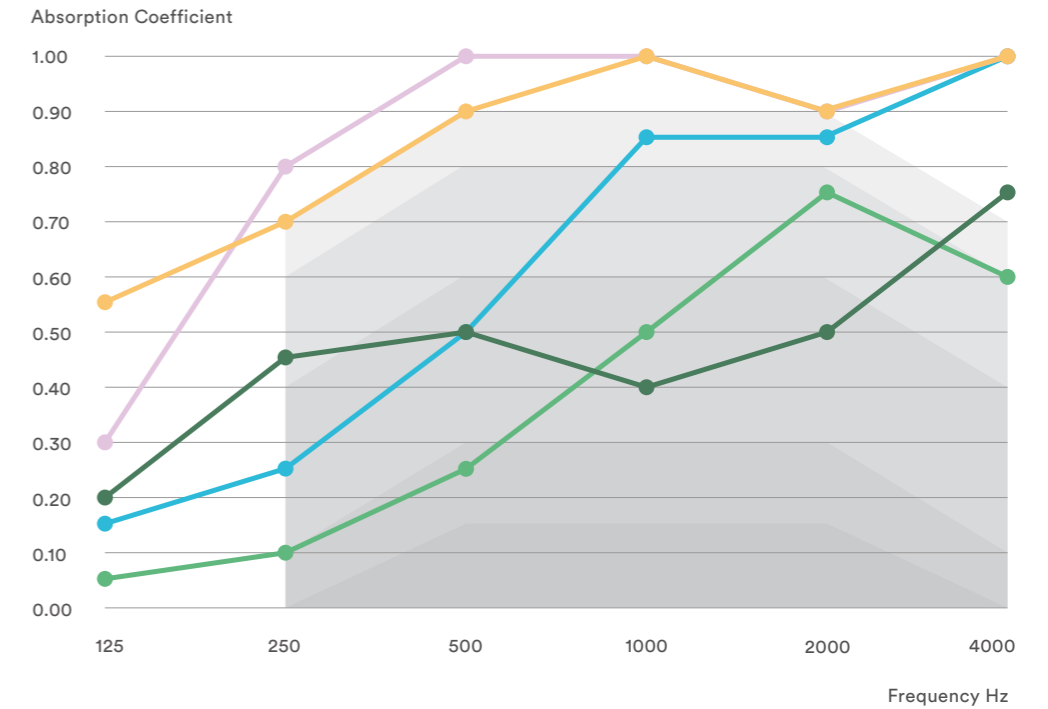

| Installation method | Product | aw | NRC | SAA | Class |
|--|--|-----------|------|------|-------|
| Directly mounted on wall or ceiling | ● BAUX 25 mm Any shape | 0.30 | 0.40 | 0.41 | D |
| | ● BAUX 3D Pixel Equal amount of t25/t50/t70 mm | 0.50 (MH) | 0.60 | 0.62 | D |
| | ● BAUX 25 mm +40 mm Stone Wool | 1.0 (H) | 0.95 | 0.95 | A |
| Air slot between wall or ceiling and BAUX products | ● BAUX 25 mm +200 mm slot | 0.50 (H) | 0.45 | 0.46 | D |
| | ● BAUX 25 mm +40 mm Stone Wool +200 mm slot | 0.90 (H) | 0.90 | 0.90 | A |

aw = Weighted sound absorption coefficient. NRC = Noise Reduction Coefficient. SAA = Sound Absorption Average (ASTM C423).
Stone Wool in use: 40mm stone wool panel 140 kg/m3. Using Stone Wool as a backing may require screws or a frame around the tiles to fix the tiles appropriately.

Wall products:

BAUX Acoustic Wood Wool Tiles

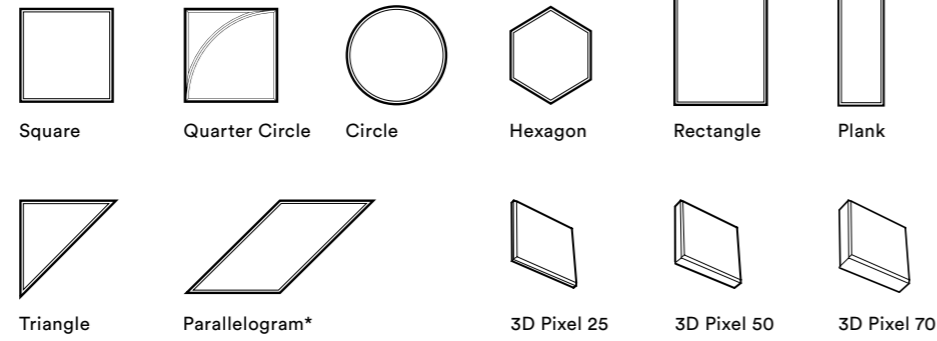

BAUX Acoustic Wood Wool Panels

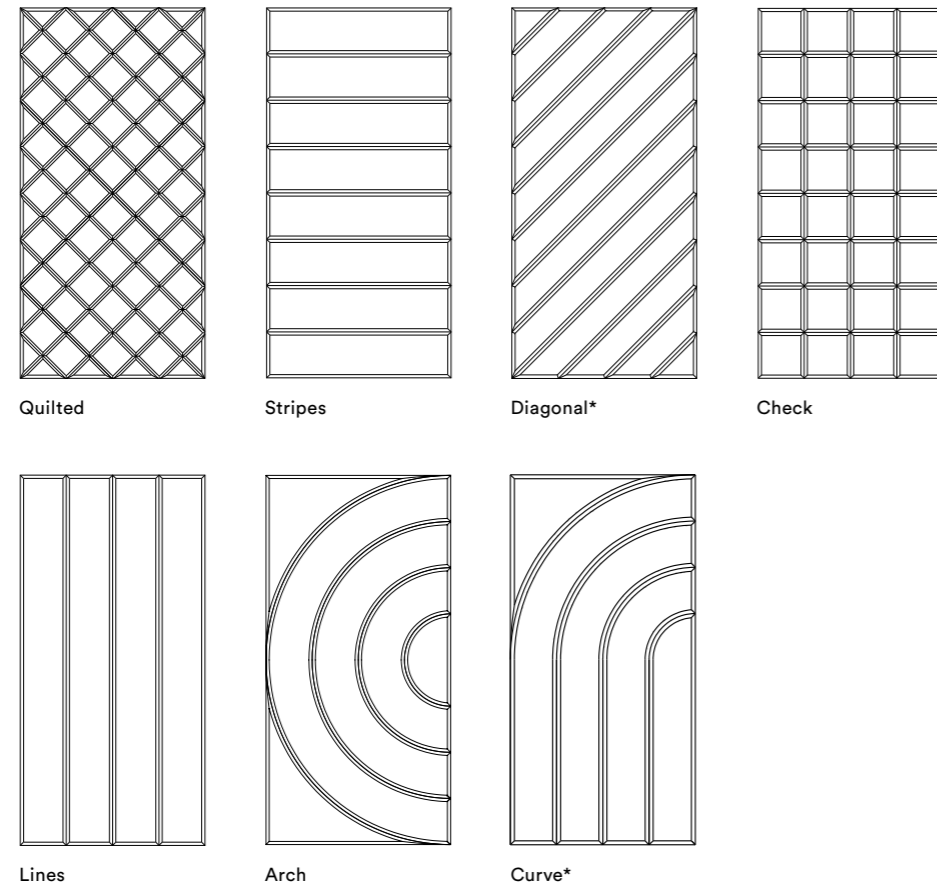

*Available both left and right

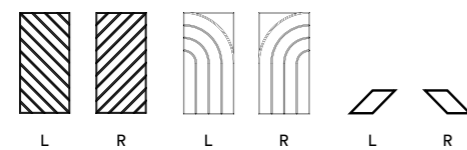

Dimensions:

Tiles

| Product: | Models: | Width: (mm & inch) | Height: (mm & inch) | Thickness: (mm & inch) | Tiles per m2 and sq.ft. |
|----------------|---------|-----------------------|------------------------|---------------------------|----------------------------|
| Square | Small | 290 mm, 11.42" | 290 mm, 11.42" | 25 mm, 1.0" | 11.82/m2, 1.10/sq.ft. |
| | Large | 580 mm, 22.84" | 580 mm, 22.84" | 25 mm, 1.0" | 2.97/m2, 0.28/sq.ft. |
| Quarter Circle | Small | 290 mm, 11.42" | 290 mm, 11.42" | 25 mm, 1.0" | 11.82/m2, 1.10/sq.ft. |
| | Large | 580 mm, 22.84" | 580 mm, 22.84" | 25 mm, 1.0" | 2.97/m2, 0.28/sq.ft. |
| Circle | Small | 290 mm, 11.42" | 290 mm, 11.42" | 25 mm, 1.0" | 15.14/m2, 1.41/sq.ft. |
| | Large | 580 mm, 22.84" | 580 mm, 22.84" | 25 mm, 1.0" | 3.78/m2, 0.35/sq.ft. |
| Hexagon | Small | 290 mm, 11.42" | 250 mm, 9.84" | 25 mm, 1.0" | 17.82/m2, 1.66/sq.ft. |
| | Large | 580 mm, 22.84" | 500 mm, 19.68" | 25 mm, 1.0" | 4.45/m2, 0.41/sq.ft. |
| Rectangle | Small | 580 mm, 22.84" | 290 mm, 11.42" | 25 mm, 1.0" | 5.95/m2, 0.55/sq.ft. |
| | Large | 1160 mm, 45.7" | 580 mm, 22.84" | 25 mm, 1.0" | 1.49/m2, 0.14/sq.ft. |
| Plank | Small | 580 mm, 22.84" | 145 mm, 5.71" | 25 mm, 1.0" | 11.89/m2, 1.10/sq.ft. |
| | Large | 1160 mm, 45.7" | 290 mm, 11.42" | 25 mm, 1.0" | 2.97/m2, 0.28/sq.ft. |
| Parallelogram | Small | 290 mm, 11.42" | 580 mm, 22.84" | 25 mm, 1.0" | 11.89/m2, 1.10/sq.ft. |
| | Large | 580 mm, 22.84" | 1160 mm, 45.7" | 25 mm, 1.0" | 2.97/m2, 0.28/sq.ft. |
| Triangle | Small | 290 mm, 11.42" | 290 mm, 11.42" | 25 mm, 1.0" | 23.78/m2, 2.21/sq.ft. |
| | Large | 580 mm, 22.84" | 580 mm, 22.84" | 25 mm, 1.0" | 5.95/m2, 0.55/sq.ft. |
| 3D Pixel 25 | t25 | 290 mm, 11.42" | 290 mm, 11.42" | 25 mm, 1.0" | 11.89/m2, 1.10/sq.ft. |
| 3D Pixel 50 | t50 | 290 mm, 11.42" | 290 mm, 11.42" | 50 mm, 1.96" | 11.89/m2, 1.10/sq.ft. |
| 3D Pixel 70 | t70 | 290 mm, 11.42" | 290 mm, 11.42" | 70 mm, 2.75" | 11.89/m2, 1.10/sq.ft. |

Panels

| Product: | Width: (mm & inch) | Height: (mm & inch) | Thickness: (mm & inch) | Panels per m2 and sq.ft. |
|----------|-----------------------|------------------------|---------------------------|-----------------------------|
| Quilted | 1160 mm, 45.7" | 580 mm, 22.84" | 25 mm, 1.0" | 1.49/m2, 0.14/sq.ft. |
| Stripes | 1160 mm, 45.7" | 580 mm, 22.84" | 25 mm, 1.0" | 1.49/m2, 0.14/sq.ft. |
| Diagonal | 1160 mm, 45.7" | 580 mm, 22.84" | 25 mm, 1.0" | 1.49/m2, 0.14/sq.ft. |
| Check | 1160 mm, 45.7" | 580 mm, 22.84" | 25 mm, 1.0" | 1.49/m2, 0.14/sq.ft. |
| Lines | 1160 mm, 45.7" | 580 mm, 22.84" | 25 mm, 1.0" | 1.49/m2, 0.14/sq.ft. |
| Arch | 1160 mm, 45.7" | 580 mm, 22.84" | 25 mm, 1.0" | 1.49/m2, 0.14/sq.ft. |
| Curve | 1160 mm, 45.7" | 580 mm, 22.84" | 25 mm, 1.0" | 1.49/m2, 0.14/sq.ft. |

Installation:

BAUX Acoustic Wood Wool Panels & Tiles can be installed on walls using a variety of different installation methods, including the use of glue, screws and magnets. Suitable for projects of all kinds, Acoustic Wood Wool panels fulfil a range of acoustic treatment needs—from A to D class, and NRC requirements up to 0.95. Download the installation manuals at baux.com.

Ceiling products: BAUX Acoustic Wood Wool Ceilings

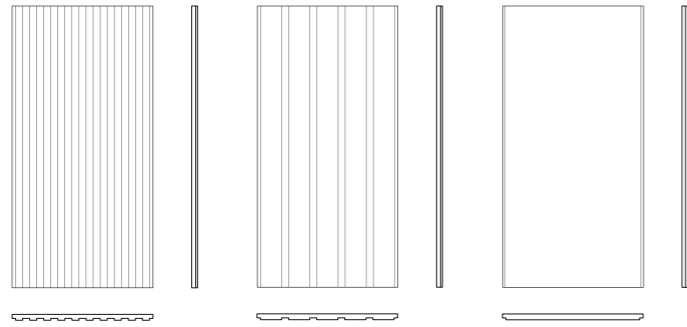

Pinstripe Widestripe Flat

Edges: Widestripe and Pinstripe come with a tegular edge.
Flat panels come with either tegular edge or beveled (10x10 mm).

| Product: | Width: (mm & feet) | Height: (mm & feet) | Thickness: (mm & inch) | Panels per m2 and sq.ft. |
|-------------|-----------------------|------------------------|---------------------------|-----------------------------|
| Pinstripe* | 600 mm, 2 feet | 1200 mm, 4 feet | 25 mm, 1.0" | 1.39/m2, 0.129/sq.ft. |
| Widestripe* | 600 mm, 2 feet | 1200 mm, 4 feet | 25 mm, 1.0" | 1.39/m2, 0.129/sq.ft. |
| Flat* | 600 mm, 2 feet | 1200 mm, 4 feet | 25 mm, 1.0" | 1.39/m2, 0.129/sq.ft. |

* Dimensions also available to fit exposed lay-in grids

- Installation:** **Three ways to install**
- Directly adhered to ceiling using wooden battens and screws
 - Suspended drywall grid with screws (concealed grid)
 - Suspended t-grid with lay-in panels (exposed grid)

Acoustic stone wool can be applied behind each option to increase the acoustic performance.

Download the installation manuals at baux.com.

Colours:

Woods



Woods Pine Green



Woods Moss Green



Woods Bright Green



Woods Pale Green

Sky in the sea



Sky Navy Blue



Sky Antique Blue



Sky Day Blue



Sky Dusk Blue

Heat of the sun



Heat Clay Red



Heat Rust Red



Heat Skin Red



Heat Peach Red

Earth and mountain



Earth Soil Brown



Earth Brown



Earth Sand Brown



Earth Dust Brown

Clouds



Clouds Black



Clouds Dark Grey



Clouds Grey



Clouds White

Natural



Unpainted wood wool

Custom colours



Custom colours available upon request.

Production: Production locations: Raw material: Sweden. Finishing: Sweden, USA, Australia.
Waste in production: 80% of waste (wood wool) from production is used to heat the factory and drying plant. No waste is produced from the timber log.

Certificates: Regulation/protocol (VOC Test Report Indoor Air Comfort GOLD)

French VOC Regulation: 

French CMR components: Pass

AgBB/ABG: Pass

Belgian Regulation: Pass

Indoor Air Comfort*: Pass

Indoor Air Comfort GOLD®: Pass

EN 717-1§: E1

BREEAM International: Compliant

LEED v4: Compliant

BREEAM® NOR: Pass

Collaborations & supplier certificate



Contact: If you are interested in BAUX acoustic products, please get in touch.
We ship globally through our headquarters and via local partners and representatives.
For more information, visit baux.com or contact us at info@baux.com.

BAUX HQ - Stockholm, Sweden
baux.com/contact
0046 (8) 21 07 07
info@baux.com

